



MANUAL



ENGLISH

Compact 6.2

V1

Ordercode: D2320

Table of contents

| | |
|--|----|
| Warning | 2 |
| Safety Instructions | 2 |
| Operating Determinations..... | 4 |
| Connection with the mains | 4 |
| Return Procedure | 4 |
| Claims | 4 |
| Description of the device | 5 |
| Features | 5 |
| Frontside | 5 |
| Backside | 7 |
| Installation | 8 |
| Set Up and Operation | 8 |
| USB Player..... | 8 |
| Selecting Tracks..... | 8 |
| Starting/Pausing Playback..... | 8 |
| Stopping Playback..... | 8 |
| Repeat Function..... | 9 |
| Time Display | 9 |
| Selecting Folders | 9 |
| Pitch Selection | 9 |
| Connection Cables | 10 |
| Connection Example | 11 |
| Maintenance | 12 |
| Troubleshooting | 12 |
| Product Specifications | 12 |
| Notes | 13 |

Warning

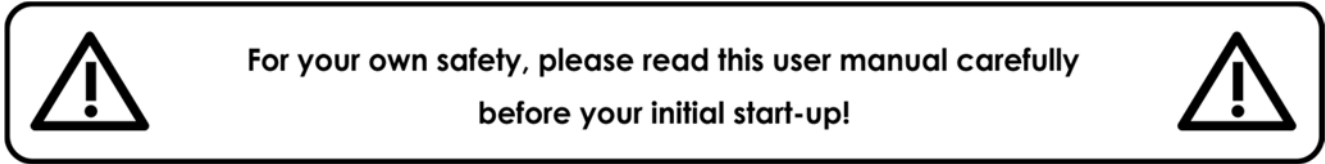

Unpacking Instructions

Immediately upon receiving this product, carefully unpack the carton and check the contents to ensure that all parts are present and have been received in good condition. Notify the dealer immediately and retain packing material for inspection if any parts appear damaged from shipping or the carton itself shows signs of mishandling. Save the carton and all packing materials. In the event that a fixture must be returned to the factory, it is important that the fixture be returned in the original factory box and packing.

Your shipment includes:

- DAP Audio Compact 6.2
- Power adapter 2 x 15V AC, 350 mA
- User manual

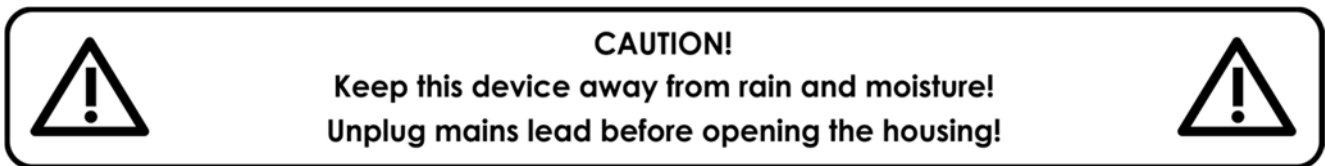

Safety Instructions

Every person involved with the installation, operation and maintenance of this system has to:

- be qualified
- follow the instructions of this manual

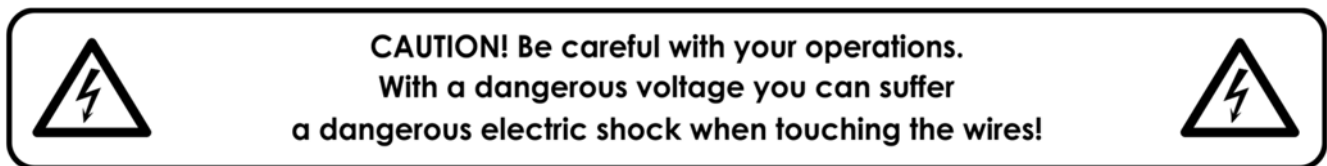

Before you initial start-up, please make sure that there is no damage caused by transportation. Should there be any, consult your dealer and do not use the system.

To maintain perfect condition and to ensure a safe operation, it is absolutely necessary for the user to follow the safety instructions and warning notes written in this manual.

Please consider that damages caused by manual modifications to the system are not subject to warranty.

This system contains no user-serviceable parts. Refer servicing to qualified technicians only.

IMPORTANT:

The manufacturer will not accept liability for any resulting damages caused by the non-observance of this manual or any unauthorized modification to the system.

- Never let the power cord come into contact with other cables! Handle the power cord and all connections with the mains with particular caution!
- Never remove warning or informative labels from the unit.
- Never use anything to cover the ground contact.
- Never leave any cables lying around.
- Do not insert objects into air vents.
- Do not connect this system to a dimmerpack.
- Do not switch the system on and off in short intervals, as this would reduce the system's life.
- Do not open the device and do not modify the device.
- Do not drive the inputs with a signal level bigger, than required to drive the equipment to full output.
- Do not plug mics into the console (or stagebox) while Phantom Power is on. Also mute the monitor / PA system when turning Phantom Power on or off. Allow the system to adjust for a couple of seconds, before setting the input gains.
- Only use system indoors, avoid contact with water or other liquids.
- Avoid flames and do not put close to flammable liquids or gases.
- Always disconnect power from the mains, when system is not used. Only handle the power cord by the plug. Never pull out the plug by tugging the power cord.
- Always operate the unit with the AC ground wire connected to the electrical system ground.
- Make sure you do not use the wrong kind of cables or defective cables.
- Make sure that the signals into the mixer are balanced, otherwise hum could be created.
- Make sure you use DI boxes to balance unbalanced signals; All incoming signals should be clear.
- Make sure that the available voltage is not higher than stated on the rear panel.
- Make sure that the power cord is never crimped or damaged. Check the system and the power cord from time to time.
- Please turn off the power switch, when changing the power cord or signal cable, or select the input mode switch.
- Extreme frequency boosts in connection with a high input signal level may lead to overdriving your equipment. Should this occur, it is necessary to reduce the input signal level by using the INPUT control.
- To emphasize a frequency range, you do not necessarily have to move its respective control upwards; try lowering surrounding frequency ranges instead. This way, you avoid causing the next piece of equipment in your sound path to overdrive. You also preserve valuable dynamic reserve ("headroom").
- Avoid ground loops! Always be sure to connect the power amps and the mixing console to the same electrical circuit to ensure the same phase!
- If system is dropped or struck, disconnect mains power supply immediately. Have a qualified engineer inspect for safety before operating.
- If the system has been exposed to drastic temperature fluctuation (e.g. after transportation), do not switch it on immediately. The arising condensation water might damage your system. Leave the system switched off until it has reached room temperature.
- If your Dap Audio device fails to work properly, discontinue use immediately. Pack the unit securely (preferably in the original packing material), and return it to your Dap Audio dealer for service.
- Repairs, servicing and electric connection must be carried out by a qualified technician.
- For replacement use fuses of same type and rating only.
- WARRANTY: Till one year after date of purchase.

Operating Determinations

- This system is not designed for permanent operation. Consistent operation breaks will ensure that the system will serve you for a long time without defects.
- If this system is operated in any other way, than the one described in this manual, the product may suffer damages and the warranty becomes void.
- Any other operation may lead to dangers like short-circuit, burns, electric shock, etc.

You endanger your own safety and the safety of others!

Improper installation can cause serious damage to people and property!

Connection with the mains

Connect the device to the mains with the power-plug.

Always pay attention, that the right color cable is connected to the right place.

| International | EU Cable | UK Cable | US Cable | Pin |
|---|--------------|----------|---------------|-------------------|
| L | BROWN | RED | YELLOW/COPPER | PHASE |
| N | BLUE | BLACK | SILVER | NEUTRAL |
|  | YELLOW/GREEN | GREEN | GREEN | PROTECTIVE GROUND |

Make sure that the device is always connected properly to the earth!

Improper installation can cause serious injuries and/or damage of property!



Return Procedure



Returned merchandise must be sent prepaid and in the original packing, call tags will not be issued. Package must be clearly labeled with a Return Authorization Number (RMA number). Products returned without an RMA number will be refused. Highlite will not accept the returned goods or any responsibility. Call Highlite 0031-455667723 or mail aftersales@highlite.nl and request an RMA prior to shipping the fixture. Be prepared to provide the model number, serial number and a brief description of the cause for the return. Be sure to properly pack fixture, any shipping damage resulting from inadequate packaging is the customer's responsibility. Highlite reserves the right to use its own discretion to repair or replace product(s). As a suggestion, proper UPS packing or double-boxing is always a safe method to use.

Note: If you are given an RMA number, please include the following information on a piece of paper inside the box:

- 1) Your name
- 2) Your address
- 3) Your phone number
- 4) A brief description of the symptoms

Claims

The client has the obligation to check the delivered goods immediately upon delivery for any short-comings and/or visible defects, or perform this check after our announcement that the goods are at their disposal. Damage incurred in shipping is the responsibility of the shipper; therefore the damage must be reported to the carrier upon receipt of merchandise.

It is the customer's responsibility to notify and submit claims with the shipper in the event that a fixture is damaged due to shipping. Transportation damage has to be reported to us within one day after receipt of the delivery.

Any return shipment has to be made post-paid at all times. Return shipments must be accompanied with a letter defining the reason for return shipment. Non-prepaid return shipments will be refused, unless otherwise agreed in writing.

Complaints against us must be made known in writing or by fax within 10 working days after receipt of the invoice. After this period complaints will not be handled anymore.

Complaints will only then be considered if the client has so far complied with all parts of the agreement, regardless of the agreement of which the obligation is resulting.

Description of the device

Features

6 Channel 1U mixer/USB player

The Compact 6.2 is the ideal mixer for sports instructors. It is equipped with 2 microphone inputs with built-in compressor limiters and high-pass filters. This will help the instructor to keep perfect intelligibility, as the dynamic range will be extended and distortion will be eliminated. The device has one selector to choose the audio source with. The available sources include: the internal USB/MP3 player, the front input or 2 line inputs at the rear panel. The MP3 player supports ID3 texts and can be pitched, which is ideal for fitness, spinning and all kinds of group workouts. The front input can be used for a normal line level but also can be switched to a special phone mode which adjusts the input sensitivity to the correct value for MP3 players, smartphones or tablets. You can now use your MP3 devices directly without signal loss. There are 2 master outputs with separate, lockable volume controls and a separate monitor volume especially for the instructor. All technical settings like EQ, Gain, Phantom Power, Compression & Threshold are on the rear side of the unit. Now, the instructor only has to set his source and mic level and does not need to worry about the other settings. The Compact 6.2 is an all-in-one solution for your sports instructor. It is easy in use and has all features which are needed to give instructions, without worrying about anything else but the audience.

- Mic input with Comp/Limit
- USB player with pitch control
- Display with ID3 text
- Direct MP3/phone input
- 2 masters & monitor outputs

Frontside

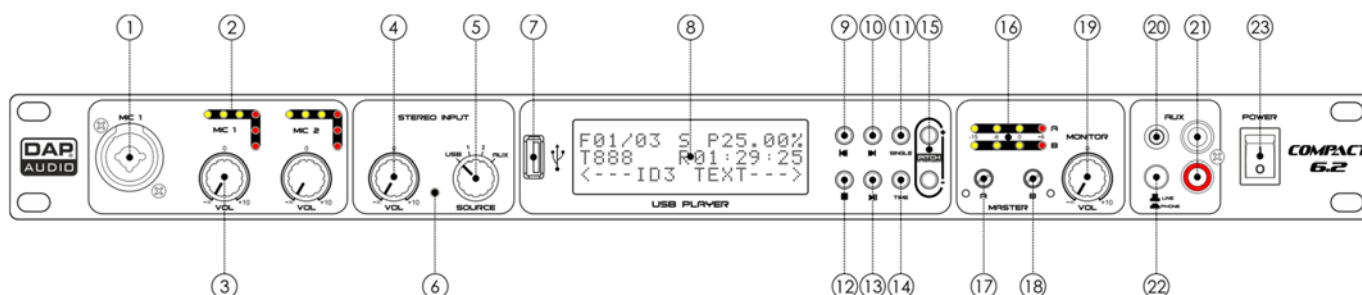





Fig. 01

- 1 Mic 1 combo input connector**
 Electronically balanced combo-type input for connecting low impedance microphones. The input has extremely low noise and hum. When connecting a microphone, make sure that the pin assignment is correct. Always make sure to read the manual of the microphone you want to connect. Use only one connector at a time: **(01)** or **(36)**.
- 2 Input VU-meter (Mic 1-2)/Compressor**
 This meter is a multi-step LED. The green LEDs allow you to monitor the input microphone signal level and make it match the other devices. The red LEDs allow you to monitor the relationship of the input signal level to the threshold of compression.
- 3 Mic Volume control (Mic 1-2)**
 Turn the control to set the volume of the corresponding microphone channel.
- 4 Level control (Stereo Input)**
 Controls the volume of the input channel.
- 5 Input source switch**
 Turn the control to select the desired signal source. Choose from the USB, line input 1 & 2 **(33,34)**, and the front aux input **(20)**.

- ⑥ **Peak LED (Stereo Input)**
The peak LED shows signal peaks in a channel's incoming signal. If the red peak LED frequently blinks or constantly lights up, the corresponding channel is likely to enter clipping. Make sure that the peak LED lights up only briefly, during dynamic peaks.
- ⑦ **USB A connector – IN**
Connect a (FAT-formatted, with a maximum capacity of 16GB) USB flash drive, containing audio files (.mp3 128-192-256-320 kbps).
- ⑧ **USB player – LCD display**
- ⑨  button
- ⑩  button
- ⑪ **SINGLE button**
- ⑫  button
- ⑬  button
- ⑭ **TIME button**
- ⑮ **Pitch +/- buttons**
- ⑯ **Output VU-meter (Zone A-B)**
This meter is a multi-step LED. The level indication allows you to monitor the output signal level and make it match the other devices.
- ⑰ **Master control (zone A)**
Turn the control to adjust the output signal to the **master zone A (28)** outputs.
- ⑱ **Master control (zone B)**
Turn the control to adjust the output signal to the **master zone B (27)** outputs.
- ⑲ **Monitor Volume control**
Turn the control to adjust the output signal of the monitor output (29).
- ⑳ **Aux in unbalanced mini jack input connector**
Unbalanced stereo mini jack aux input for connecting a line/phone level device. Use only one input at a time: RCA or mini jack.
- ㉑ **Aux in unbalanced RCA input connector**
Unbalanced stereo RCA aux input for connecting a line/phone level device. Use only one input at a time: RCA or mini jack.
- ㉒ **Phone/line button**
Press this button to configure both **aux inputs (20,21)** for either line level or phone level. When the input level is too low, press the line/phone level switch. When the light is on, the level of the input signal will be boosted. The phone level adjusts the input sensitivity to the correct level for MP3 players, smartphones or tablets. Now you can playback your MP3 devices directly without signal loss.
- ㉓ **Power switch ON/OFF**
Do not supply power before the whole system is set up and connected properly.

Backside

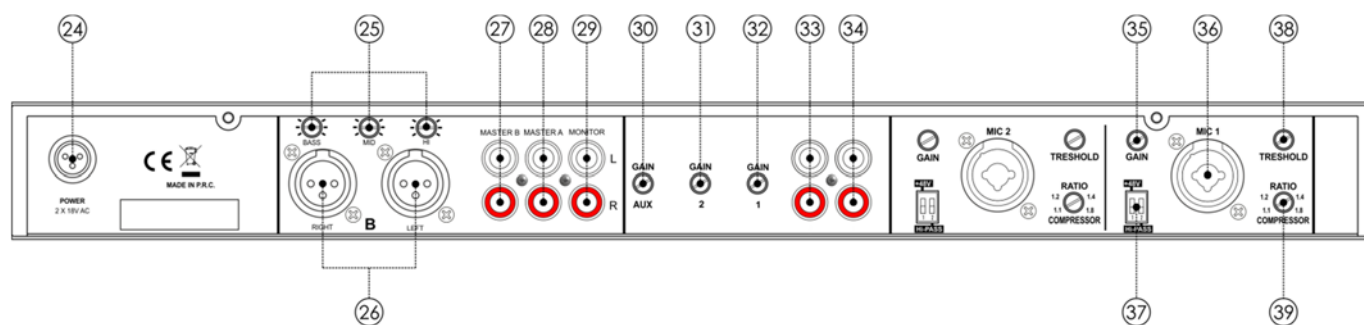

Fig. 02

- 24 Power adapter connector**
The remote AC power supply. Use only the supplied DAP Audio adapter.
- 25 Master Equalizer**
The output equalizer allows to shape the outgoing audio signal. The high and low shelving controls have their frequencies fixed at 12kHz and 80Hz, respectively. The mid-range control has a peaking response frequency at 2,5kHz. All 3 bands have up to 6dB of cut and boost, with a center detent for off. Turning the equalizer control to the right amplifies the frequency range, turning to the left attenuates the signal. Minor changes to the equalizer control usually produce the best results. Try to avoid excessive enhancement of the mid band.
- 26 Master B XLR balanced out connector**
Connect an amplifier with balanced inputs.
- 27 Master B RCA unbalanced out connector**
RCA output. Connect an amplifier/active speaker with unbalanced inputs.
- 28 Master A RCA unbalanced out connector**
RCA output. Connect an amplifier/active speaker with unbalanced inputs.
- 29 Monitor RCA unbalanced out connector**
RCA output. Connect an amplifier/active speaker with unbalanced inputs.
- 30 Channel gain control (AUX front input)**
Channel input levels (**20,21**) are determined by their corresponding gain controls. With the gain control you can adjust the line input sensitivity, while optimally matching the incoming signals to the mixer's internal operation level. The high gain of this mixer is ideal when dealing with very low input levels.
- 31 Channel gain control (input 2)**
Channel input levels (**33**) are determined by their corresponding gain controls. With the gain control you can adjust the line input sensitivity, while optimally matching the incoming signals to the mixer's internal operation level. The high gain of this mixer is ideal when dealing with very low input levels.
- 32 Channel gain control (input 1)**
Channel input levels (**34**) are determined by their corresponding gain controls. With the gain control you can adjust the line input sensitivity, while optimally matching the incoming signals to the mixer's internal operation level. The high gain of this mixer is ideal when dealing with very low input levels.
- 33 Line input 2 connector**
RCA input. Connect a line level device.
- 34 Line input 1 connector**
RCA input. Connect a line level device.
- 35 Mic gain control (Mic 1-2 inputs)**
The microphone input level is determined by the gain control. Turn the gain control to adjust the microphone input sensitivity for an optimal match with the mixer's internal operation level.
- 36 Mic 1-2 combo input connector**
Electronically balanced combo-type input for connecting low impedance microphones. The input has extremely low noise and hum. When connecting a microphone, make sure that the pin assignment is correct. Always make sure to read the manual of the microphone you want to connect. Use only one connector at a time: (**01**) or (**36**).
- 37 DIP Switch (Phantom power on/off / Hi-Pass 80Hz on/off)**
Switch # 1 (Phantom power ON/OFF), switch # 2 (Hi-Pass filter ON/OFF).

- ③⑧ **Threshold control**
Turn the control to set the threshold of compression.
- ③⑨ **Ratio/Compressor control**
Turn the control to adjust the ratio of the compressor.

Installation

Remove all packing materials from the Compact 6.2. Check that all foam and plastic padding is removed. Connect all cables.

Do not supply power before the whole system is set up and connected properly.

Always disconnect from electric mains power supply before cleaning or servicing.

Damages caused by non-observance are not subject to warranty.

Set Up and Operation

Follow the directions below, as they pertain to your preferred operation mode.

Before plugging the unit in, always make sure that the power supply matches the product specification voltage. Do not attempt to operate a 115V specification product on 230V power, or vice versa.

USB Player

- 01) Insert a USB flash drive into the **USB connector (07)**.
- 02) Turn the **input source switch (05)** to select USB.
- 03) The display will show:

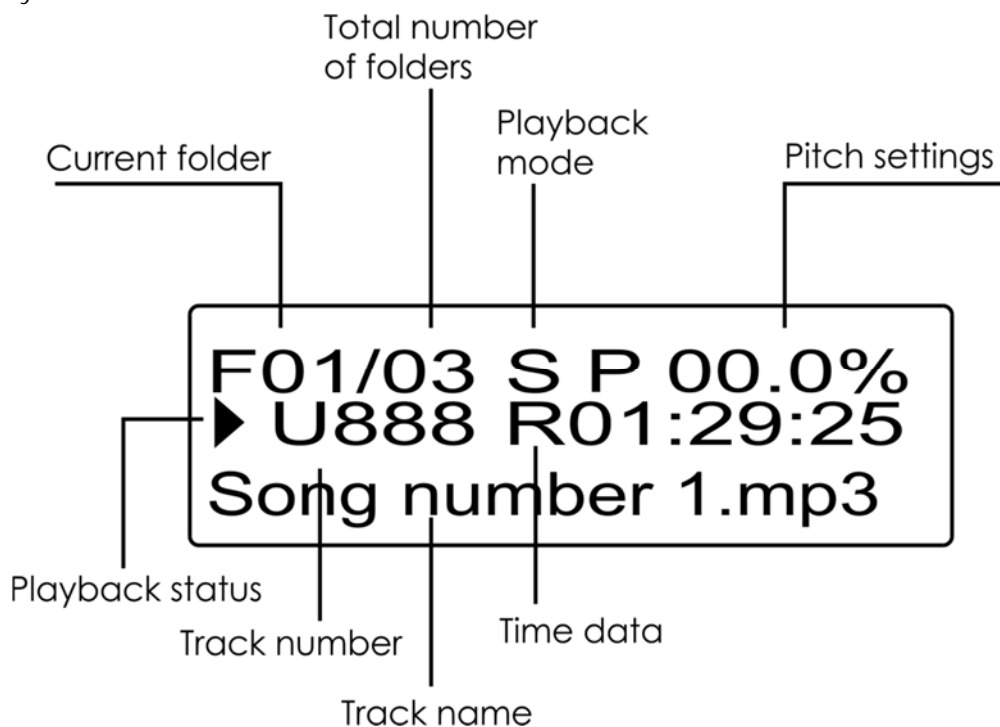

Selecting Tracks

- 01) Press the skip buttons **⏮** and **⏭** to select previous/next track. The selected track's name and time data will appear on the display.
- 02) Press and hold down the skip buttons **⏮** and **⏭** to rewind/fast-forward the selected track.



Starting/Pausing Playback

- 01) Once you have selected the desired track, press the **▶** button to start playback.
- 02) Press the **⏸** button again, to pause playback.

Stopping Playback

- 01) Press the **■** button to stop playback.

Repeat Function

- 01) Repeatedly press the **SINGLE button (11)** to toggle between the following playback modes:
- **A** – Once the final track from a given folder has passed, the player will skip to the following folder, starting playback from the first track on the list.
 - **F** – Once the final track from the selected folder has passed, the audio player will replay the whole folder, starting from the first track on the list.
 - **S** – Single track mode. The player will repeat the selected track. Each press of the skip buttons  and  will cause the player to return to the beginning of the selected track.
- 02) When the display shows no playback mode indication, once the final track from the selected folder has passed, the player will stop playback.



Time Display

- 01) Repeatedly press the **TIME button (14)** to toggle between the following 2 time display modes:
- **T** – Elapsed time
 - **R** – Remaining time

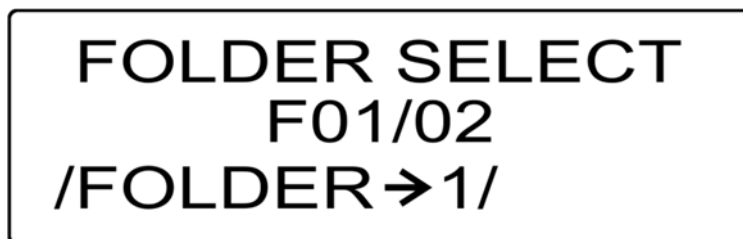

Selecting Folders

- 01) While playback is active, press and hold down the **TIME button (14)** for 3 seconds. The display will show:



- 02) Press the skip buttons  and  to select the desired folder.
- 03) Press the  button to enter the selected folder. The display will show:



- 04) Press the skip buttons  and  to select the desired track/folder within the folder.
- 05) Press the  button to play/enter the desired track/subfolder.

Pitch Selection

- 01) While playback is active, press the **+/- pitch buttons (15)** to set the desired playback pitch. The adjustment range is from -16% to +16%.
- 02) In order to restore the neutral pitch, set to 0%.

Connection Cables

Take care of your cables, always holding them by the connectors and avoiding knots and twists when coiling them: This gives the advantage of increasing their life and reliability. Periodically check your cables. A great number of problems (faulty contacts, ground hum, discharges, etc.) are caused entirely by using unsuitable or faulty cables.

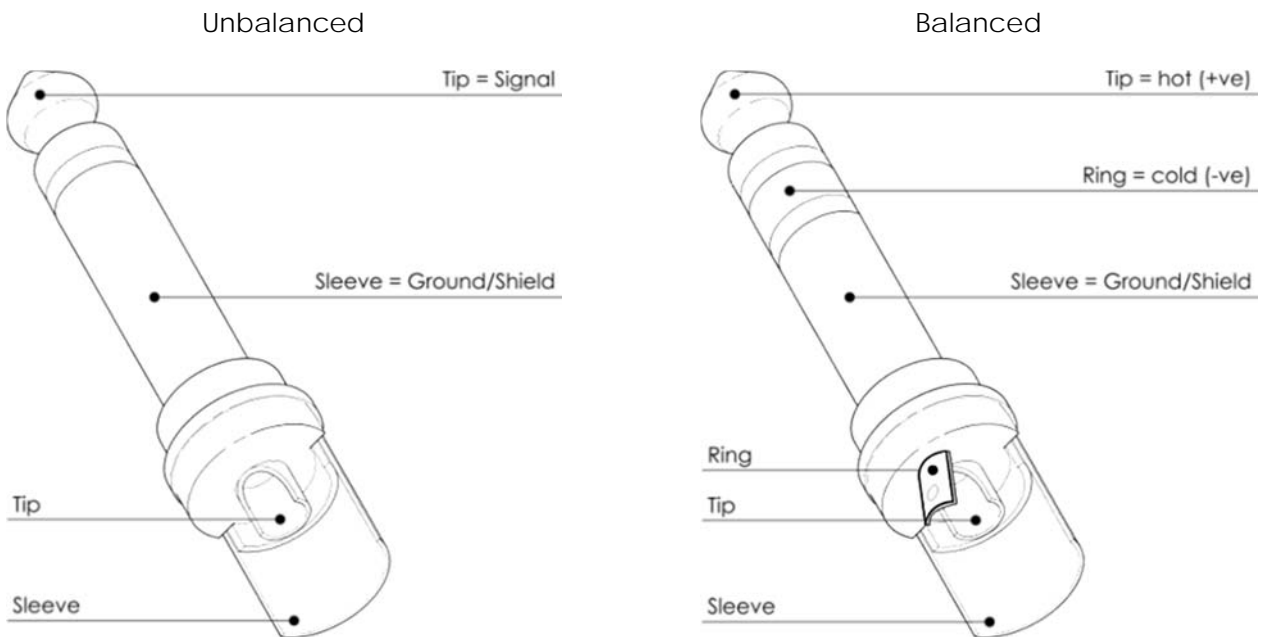

For these applications the unit provides 1/4" TRS and XLR connectors to easily interface with most professional audio devices. Follow the configuration examples below for your particular connection.

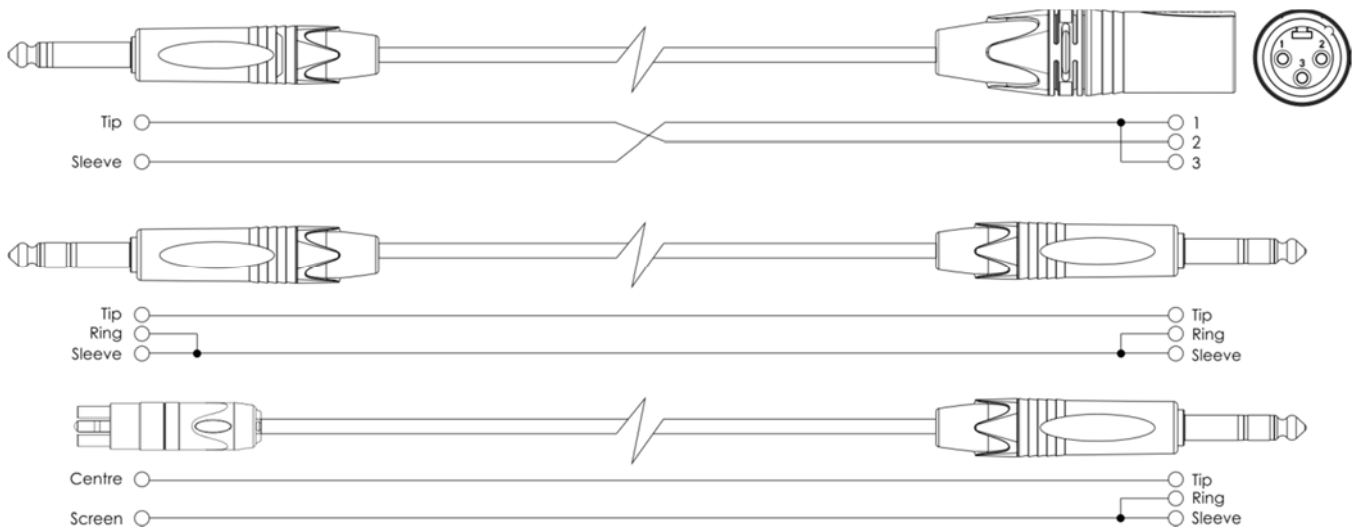

Connection Example

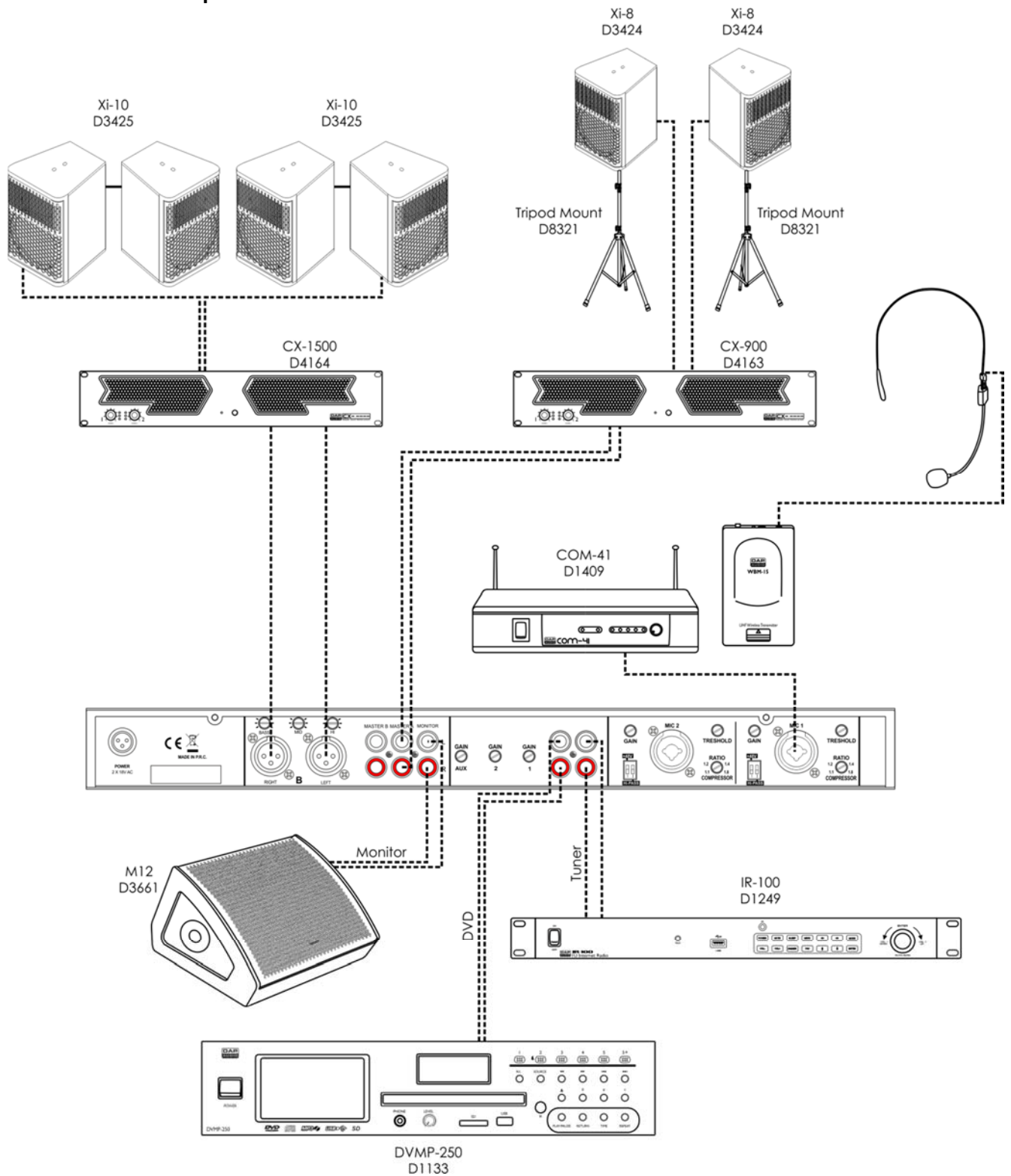

Fig. 03

Maintenance

The DAP Audio Compact 6.2 requires almost no maintenance. However, you should keep the unit clean. Disconnect the mains power supply, and then wipe the cover with a damp cloth. Do not immerse in liquid. Do not use alcohol or solvents.

Keep connections clean. Disconnect electric power, and then wipe the audio connections with a damp cloth. Make sure connections are thoroughly dry before linking equipment or supplying electric power.

Troubleshooting

This troubleshooting guide is meant to help solve simple problems. If a problem occurs, carry out the steps below in sequence until a solution is found. Once the unit operates properly, do not carry out following steps.

- 01) If the device does not operate properly, unplug the device.
- 02) Check power from the wall, all cables, connections, etc.
- 03) If all of the above appears to be O.K., plug the unit in again.
- 04) If nothing happens after 30 seconds, unplug the device.
- 05) Return the device to your DAP Audio dealer.

Product Specifications

| | |
|---------------------|---|
| Power supply: | 2 x 15V AC, 50Hz (adapter included) |
| Power consumption: | 6W |
| Input channels: | 2 x Microphone, combo XLR/jack 2 x Line, RCA |
| Output channels: | 1 x Phone, 3,5 mm jack / RCA |
| Master EQ: | 1 x Master A RCA, 1 x Master B, Balanced XLR/RCA, 1 x Monitor RCA |
| Frequency response: | 80Hz, 2,5kHz, 12kHz, -6dB / +6dB |
| T.H.D.: | 20Hz – 20kHz |
| USB format: | <0.01% |
| Dimensions: | FAT-formatted, with a maximum capacity of 16GB |
| Weight: | 481 x 175 x 44 mm (LxWxH) |
| | 2,2 kg |

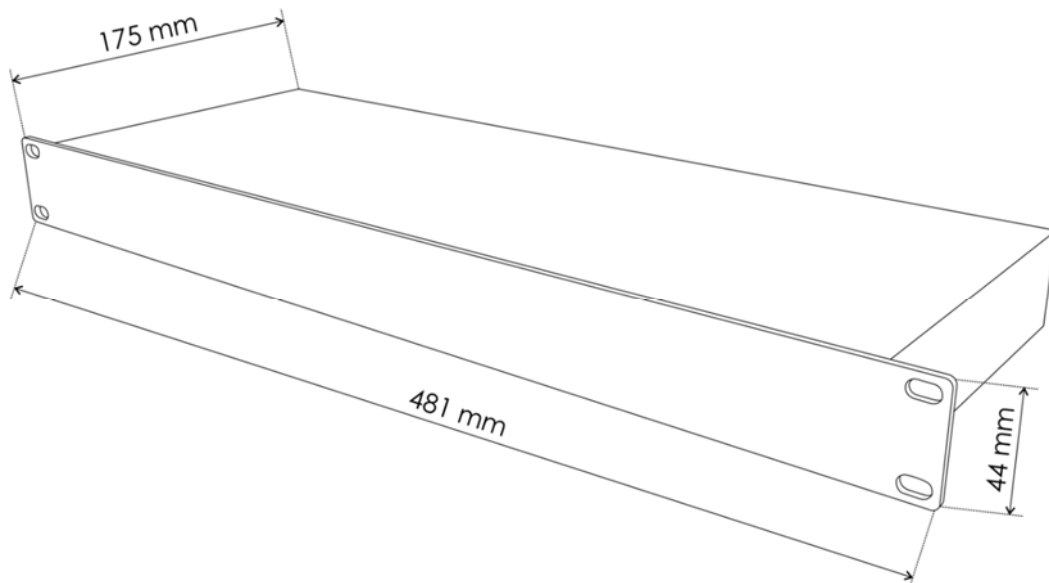

Design and product specifications are subject to change without prior notice.



Website: www.Dap-audio.info
Email: service@highlite.nl



©2016 DAP Audio