

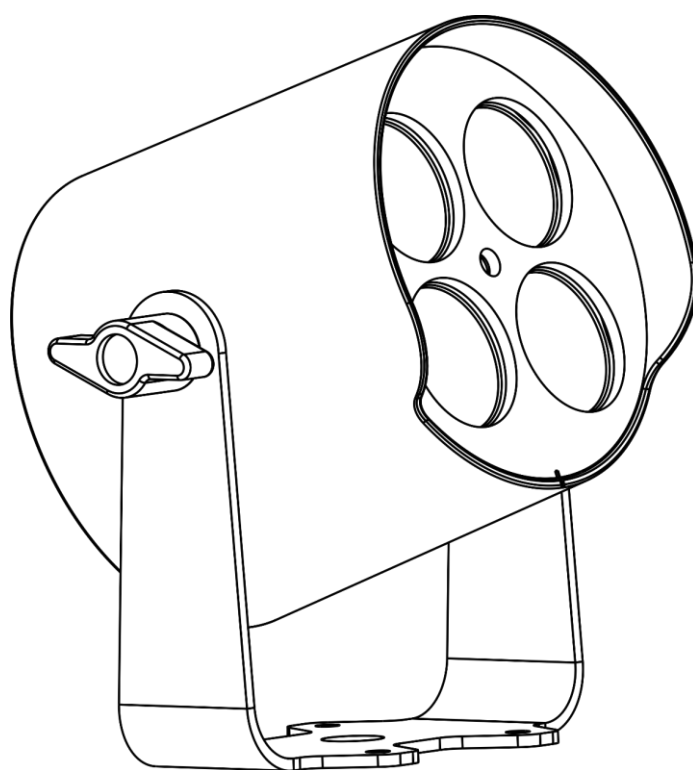

USER MANUAL



ENGLISH

EventLITE 4/8 Mini Q4

V1

Product code: 44080

Preface

Thank you for purchasing this Showtec product.

The purpose of this user manual is to provide instructions for the correct and safe use of this product.

Keep the user manual for future reference as it is an integral part of the product. The user manual shall be stored at an easily accessible location.

This user manual contains information concerning:

- Safety instructions
- Installation and operation of the device
- Intended and non-intended use of the device
- Maintenance procedures
- Troubleshooting
- Transport, storage and disposal of the device

Non-observance of the instructions in this user manual may result in serious injuries and damage of property.

©2023 Showtec. All rights reserved.

No part of this document may be copied, published or otherwise reproduced without the prior written consent of Highlite International.

Design and product specifications are subject to change without prior notice.

For the latest version of this document or other language versions, please visit our website www.highlite.com or contact us at service@highlite.com.

Highlite International and its authorized service providers are not liable for any injury, damage, direct or indirect loss, consequential or economic loss or any other loss arising from the use of, or inability to use or reliance on the information contained in this document.

Table of contents

| | |
|---|-----------|
| 1. Introduction | 4 |
| 1.1. Before Using the Product | 4 |
| 1.2. Intended Use | 4 |
| 1.3. Product Lifespan | 4 |
| 1.4. LEDs Lifespan | 4 |
| 1.5. Text Conventions | 5 |
| 1.6. Symbols and Signal Words | 5 |
| 1.7. Symbols on the Information Label | 5 |
| 2. Safety | 6 |
| 2.1. Warnings and Safety Instructions | 6 |
| 2.2. Requirements for the User | 8 |
| 3. Description of the Device | 9 |
| 3.1. Front View | 9 |
| 3.2. Back View | 10 |
| 3.3. Product Specifications | 11 |
| 3.4. Dimensions | 12 |
| 4. Installation | 13 |
| 4.1. Safety Instructions for Installation | 13 |
| 4.2. Personal Protective Equipment | 13 |
| 4.3. Installation Site Requirements | 13 |
| 4.4. Rigging | 14 |
| 4.4.1. Angle Adjustment | 15 |
| 4.5. Charging the Battery | 15 |
| 5. Setup | 16 |
| 5.1. Warnings and Precautions | 16 |
| 5.2. Stand-alone Setup | 16 |
| 6. Operation | 17 |
| 6.1. Safety Instructions for Operation | 17 |
| 6.2. Control Modes | 17 |
| 6.3. Control Panel | 18 |
| 6.4. Start-up | 18 |
| 6.5. Menu Overview | 19 |
| 6.6. Main Menu Options | 20 |
| 6.6.1. Auto Mode | 20 |
| 6.6.2. Built-in Programs | 20 |
| 6.6.2.1. Program 01 | 20 |
| 6.6.2.2. Programs 02–16 | 21 |
| 6.6.3. Static color control | 21 |
| 6.6.4. Sound-controlled mode | 21 |
| 6.6.5. Settings | 22 |
| 6.6.6. Info | 22 |
| 6.7. Remote Control | 23 |
| 6.7.1. Auto mode | 25 |
| 6.7.2. Built-in Programs | 25 |
| 6.7.2.1. Sound-controlled mode | 25 |
| 6.7.2.2. Program Speed | 26 |
| 6.7.2.3. Strobe | 26 |
| 6.7.3. Manual | 26 |
| 6.7.3.1. Color Presets | 26 |
| 7. Troubleshooting | 27 |

8. Maintenance28
8.1. Safety Instructions for Maintenance28
8.2. Preventive Maintenance28
8.2.1. Basic Cleaning Instructions28
8.2.2. Draining Condensation Water29
8.3. Corrective Maintenance29

9. Deinstallation, Transportation and Storage30
9.1. Instructions for Deinstallation30
9.2. Instructions for Transportation30
9.3. Storage30

10. Disposal30

11. Approval30

1. Introduction

1.1. Before Using the Product



Important

Read and follow the instructions in this user manual before installing, operating or servicing this product.

The manufacturer will not accept liability for any resulting damages caused by the non-observance of this manual.

After unpacking, check the contents of the box. If any parts are missing or damaged, contact your Highlite International dealer.

Your shipment includes:

- Showtec EventLITE 4/8 Mini Q4
- AC Power Adapter (1,1 m)
- IR Remote control
- User manual

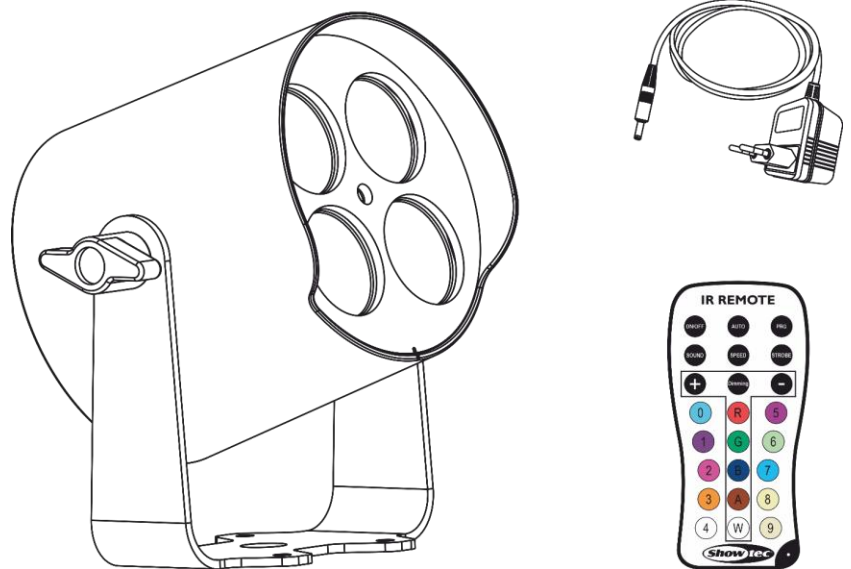

Fig. 01

1.2. Intended Use

This device is intended for professional use as a professional outdoor spot. It is not suitable for households and for general lighting.

Any other use, not mentioned under intended use, is regarded as non-intended and incorrect use.

1.3. Product Lifespan

This device is not designed for permanent operation. Disconnect the device from the electrical power supply when the device is not in operation. This will reduce the wear and will improve the device's lifespan.

1.4. LEDs Lifespan

The light output of the LEDs gradually decreases over time (lumen depreciation). High operating temperatures contribute to this process. You can extend the lifespan of the LEDs by providing adequate ventilation and operating the LEDs at the lowest possible brightness.

1.5. Text Conventions

Throughout the user manual the following text conventions are used:

- Buttons: All buttons are in bold lettering, for example "Press the **UP/DOWN** buttons"
- References: References to chapters and parts of the device are in bold lettering, for example: "Refer to **2. Safety**", "turn the **adjustment handle (05)**"
- 0–255: Defines a range of values
- Notes: **Note:** (in bold lettering) is followed by useful information or tips

1.6. Symbols and Signal Words

Safety notes and warnings are indicated throughout the user manual by safety signs.

Always follow the instructions provided in this user manual.



DANGER

Indicates an imminently hazardous situation which, if not avoided, will result in death or serious injury.



WARNING

Indicates a potentially hazardous situation which, if not avoided, could result in death or serious injury.



CAUTION

Indicates a potentially hazardous situation, which, if not avoided, may result in minor or moderate injury.



Attention

Indicates important information for the correct operation and use of the product.



Important

Read and observe the instructions in this document.



Electrical hazard



Eye damage hazard



Provides important information about the disposal of this product.



1.7. Symbols on the Information Label

This product is provided with an information label. The information label is located on the mounting bracket of the device.

The information label contains the following symbols:



This device shall not be treated as household waste.



IP65

This device is rated IP65.



This device falls under IEC protection class I.



Read the user manual supplied with the device.

2. Safety



Important
Read and follow the instructions in this user manual before installing, operating or servicing this product.

The manufacturer will not accept liability for any resulting damages caused by the non-observance of this manual.

2.1. Warnings and Safety Instructions



DANGER
Danger for children

For adult use only. The device must be installed beyond the reach of children.

- Do not leave various parts of the packaging (plastic bags, polystyrene foam, nails, etc.) within children's reach. Packaging material is a potential source of danger for children.



DANGER
Electric shock caused by dangerous voltage inside

There are areas within the device where dangerous touch voltage may be present.

- Do not open the device or remove any covers.
- Do not operate the device if the covers or the housing are open. Before operation, check if the housing is firmly closed and all screws are tightly fastened.
- Disconnect the device from electrical power supply before service and maintenance, and when the device is not in use.



DANGER
Electric shock caused by short-circuit

This device falls under IEC protection class I.

- Make sure that the device is electrically connected to ground (earth). Connect the device only to a socket-outlet with ground (earth) connection.
- Do not cover the ground (earth) connection.
- Do not bypass the thermostatic switch or fuses.
- Do not let the power cable come into contact with other cables. Handle the power cable and all connections with the mains with caution.
- Do not modify, bend, mechanically strain, put pressure on, pull or heat up the power cable.
- Make sure that the power cable is not crimped or damaged. Examine the power cable periodically for any defects.
- Do not immerse the device in water or other liquids. Do not install the device in a location where flooding may occur.
- Do not use the device during thunderstorms. Disconnect the device from the electrical power supply immediately.
- Keep the connectors sealed with the rubber caps when the connectors are not in use.
- Do not connect the cables from above the connectors, if the device is installed outdoors. Make a 'drip loop' in the cable so that rain water cannot enter the device.



WARNING
Risk of epileptic shock

Strobe lighting can trigger seizures in photosensitive epilepsy. Sensitive persons should avoid looking at strobe lights.



CAUTION
Possible eye damage caused by high light intensity

Possibly hazardous optical radiation emitted from this device.

- Do not look at the operating light source. May be harmful to the eye.
- Do not look at the light source with optical instruments that may concentrate the light output.
- Make sure that persons are not looking directly into the light source when the device lights up suddenly. This can happen when the device is powered or when it receives DMX signal, or when certain menu items are selected.
- Disconnect power supply before servicing.
- Wear protective goggles if looking into light source during service or maintenance.



Attention
Power supply

- Before connecting the device to the power supply, make sure that the current, voltage and frequency match the input voltage, current and frequency specified on the information label on the device.
- Make sure that the cross-sectional area of the extension cords and power cables is sufficient for the required power consumption of the device.



Attention
General safety

- Do not connect the device to a dimmer pack.
- Do not switch the device on and off in short intervals. This decreases the device's life.
- Do not shake the device. Avoid brute force when installing or operating the device.
- Change the lens or the LEDs if they are visibly damaged to such an extent that their effectiveness is impaired, for example by cracks or deep scratches. Contact your Highlite International dealer for more information, as servicing can be performed only by instructed or skilled persons.
- If the device is dropped or struck, disconnect the device from the electrical power supply immediately.
- If the device is exposed to extreme temperature variations (e.g. after transportation), do not switch it on immediately. Let the device reach room temperature before switching it on, otherwise it may be damaged by the formed condensation.
- If the device fails to work properly, discontinue the use immediately.



Attention
For professional use only
This device shall be used only for the purposes it is designed for.

This device is designed to be used as a professional outdoor spot. Any incorrect use may lead to hazardous situations and result in injuries and material damage.

- This device is not suitable for households and for general lighting.
- This device is not designed for permanent operation.
- This device does not contain user-serviceable parts. Unauthorized modifications to the device will render the warranty void. Such modifications may result in injuries and material damage.



Attention

Before each use, examine the device visually for any defects.

Make sure that:

- All screws used for installing the device or parts of the device are tightly fastened and are not corroded.
- The safety devices are not damaged.
- There are no deformations on housings, fixations and installation points.
- The lens is not cracked or damaged.
- The power cables are not damaged and do not show any material fatigue.



Attention

Do not expose the device to conditions that exceed the rated IP class conditions.

This device is IP65 rated. IP (Ingress Protection) 65 class means that the device is dust-tight and protected against harmful effect of water jets.

2.2. Requirements for the User

This product may be used by ordinary persons. Maintenance may be carried by ordinary persons. Installation and service shall be carried out only by instructed or skilled persons. Contact your Highlite International dealer for more information.

Instructed persons have been instructed and trained by a skilled person, or are supervised by a skilled person, for specific tasks and work activities associated with the installation, service and maintenance of this product, so that they can identify risks and take precautions to avoid them.

Skilled persons have training or experience, which enables them to recognize risks and to avoid hazards associated with the installation, service and maintenance of this product.

Ordinary persons are all persons other than instructed persons and skilled persons. Ordinary persons include not only users of the product but also any other persons that may have access to the device or who may be in the vicinity of the device.

3. Description of the Device

The Showtec EventLITE 4/8 Mini is a battery-powered RGBW spot in a sturdy, IP65-rated aluminium housing. The battery will last up to 11 hours on a single colour when it is fully charged. The EventLITE 4/8 includes several presets and sound-activated programs, and can be controlled through the display and buttons on the back or by the included IR-remote controller.

3.1. Front View

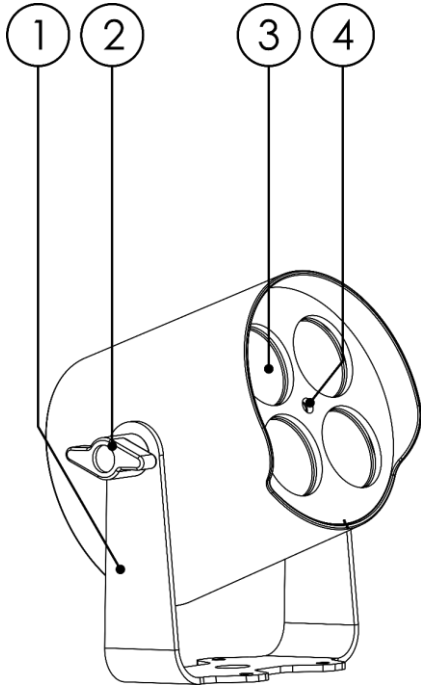

- 01) Mounting bracket
- 02) 2 x adjustment screw
- 03) 4 x 8 W 4-in-1 RGBW LEDs
- 04) Infrared sensor

Fig. 02

3.2. Back View

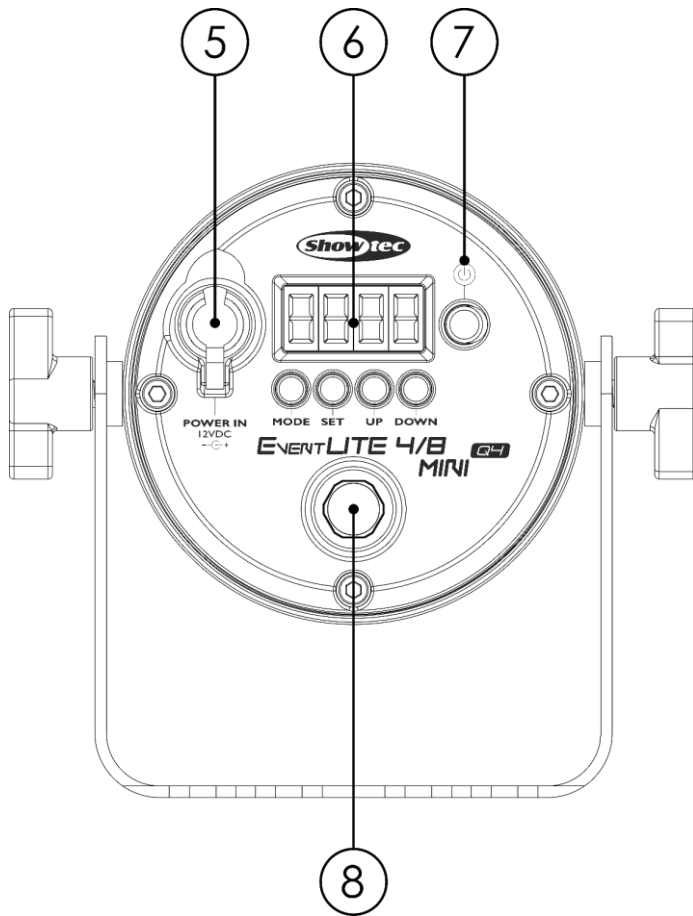

Fig. 03

- 05) DC connector, 12 V DC
- 06) LCD display + control buttons
- 07) ON / OFF button
- 08) Protective valve

3.3. Product Specifications

| | | |
|---|--|--|
| Model: | EventLITE 4/8 Mini Q4 | |
| AC power adapter: | | |
| Input voltage: | 100–240 V AC, 50/60 Hz | |
| Input current: | 0,6 A | |
| Output voltage: | 12 V DC | |
| Output current: | 1,4 A | |
| Physical: | | |
| Dimensions: | 149 x 103 x 138 mm (L x W x H) | |
| Weight: | 1 kg | |
| Optics: | | |
| Light source: | 4 x 8 W RGBW LEDs | |
| Total luminous flux: | 380 lm | |
| Red: | 77 lm | |
| Green: | 169 lm | |
| Blue: | 36 lm | |
| White: | 154 lm | |
| Illuminance @2m: | 618 lx | |
| Illuminance @3m: | 275 lx | |
| Illuminance @5m: | 100 lx | |
| CRI: | 76 | |
| CCT: | 13960 K | |
| Dimmer: | 0–100 % | |
| Strobe: | 0–20 Hz | |
| Beam Angle Circular: | 20° | |
| Refresh rate: | 3000 Hz | |
| Operation and control: | | |
| Control: | Manual, Auto, Built-in programs, IR Remote | |
| Control panel: | 7-segment LCD display and menu buttons | |
| Battery: | | |
| Battery type: | Lithium-ion | |
| Battery voltage: | 12,6 V | |
| Capacity: | 2,6 Ah | |
| Runtime (full output): | 4 h | |
| Runtime (average): | 11 h | |
| Charging time: | 5 h | |
| Construction: | | |
| Housing: | Die-cast aluminum | |
| Color: | Black | |
| IP rating: | IP65 | |
| Cooling: | Convection | |
| Thermal: | | |
| Minimum ambient temperature: | -5 °C | |
| Maximum ambient temperature t_a : | 45 °C | |
| Maximum housing temperature t_c : | 70 °C | |
| Minimum distance: | | |
| Minimum distance from flammable surfaces: | 1 m | |
| Minimum distance to lighted object: | 0,5 m | |

3.4. Dimensions

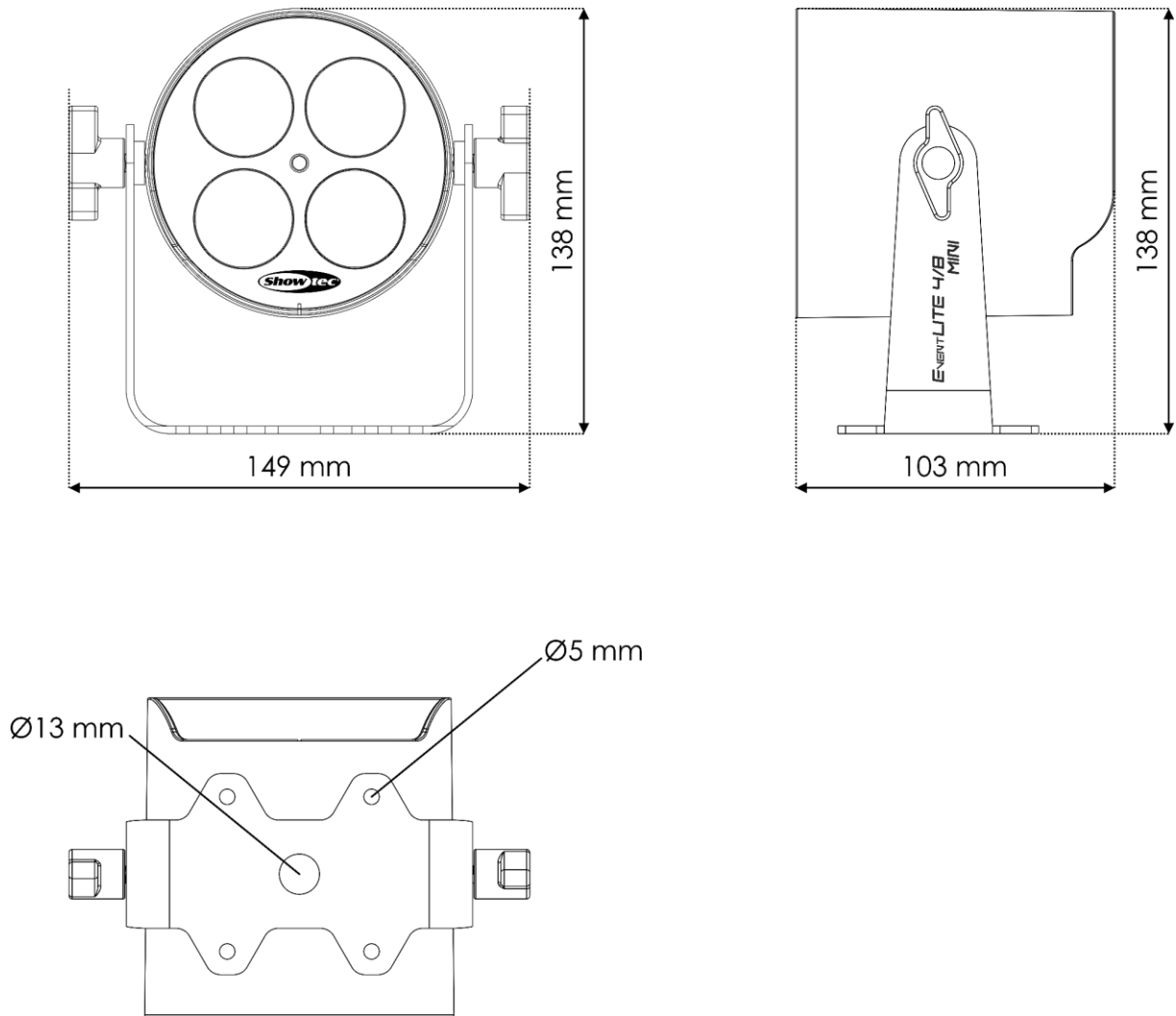

Fig. 04

4. Installation

4.1. Safety Instructions for Installation



WARNING

Incorrect installation can cause serious injuries and damage of property.

If trussing systems are used, installation must be carried out only by instructed or skilled persons.

Follow all applicable European, national and local safety regulations concerning rigging and trussing.

4.2. Personal Protective Equipment

During installation and rigging wear personal protective equipment in compliance with the national and site-specific regulations.

4.3. Installation Site Requirements

- The device can be used outdoors.
- The device can be mounted to a truss or other rigging structure.
- The minimum distance between the light output and the illuminated surface must be bigger than 0,5 m.
- The maximum ambient temperature $t_a = 45\text{ °C}$ must never be exceeded.
- The relative humidity must not exceed 50 % with an ambient temperature of 45 °C.

4.4. Rigging

The device can be positioned on a flat surface (see Fig. 06) or mounted to a truss or other rigging structure in any orientation. Make sure that all loads are within the pre-determined limits of the supporting structure.

**CAUTION**

Restrict the access under the work area during rigging and/or derigging.

To mount the device, follow the steps below:

- 01) Use a clamp to attach the device to the supporting structure, as shown in Fig. 05. Make sure that the device cannot move freely.
- 02) Secure the device with a secondary suspension, for example a safety cable. Make sure that the secondary suspension can hold 10 times the weight of the device. If possible, the secondary suspension should be attached to a supporting structure independent of the primary suspension. Put the safety cable through the **mounting bracket (01)**, as shown in Fig. 05.

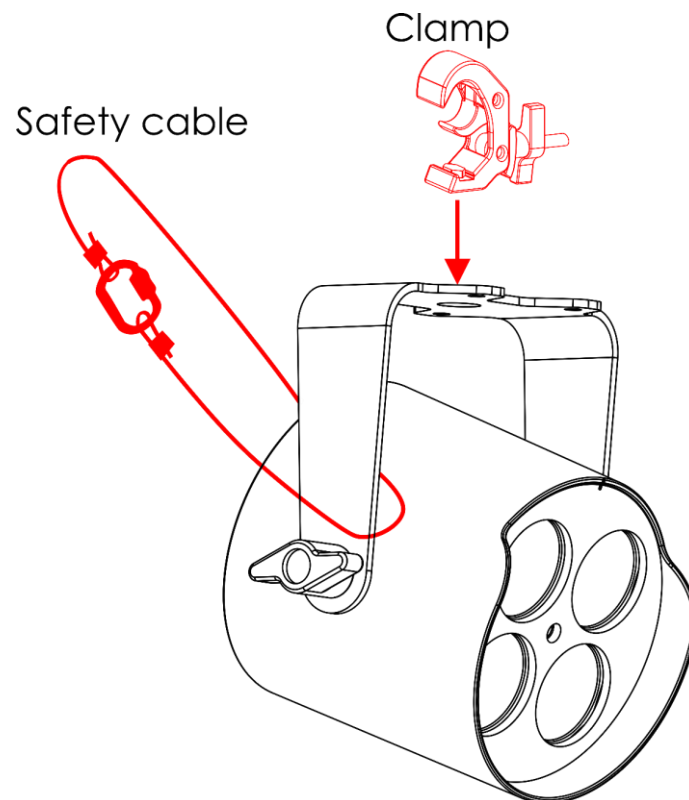

Fig. 05

4.4.1. Angle Adjustment

You can adjust the angle of the device with the 2 **adjustment screws (02)**.

- 01) Turn the **adjustment screws (02)** counterclockwise to release it.
- 02) Tilt the device at the desired angle (see Fig. 06).
- 03) Turn the **adjustment screws (02)** clockwise to tighten it. Make sure that the device cannot move freely after the **adjustment screws (02)** is tightened.

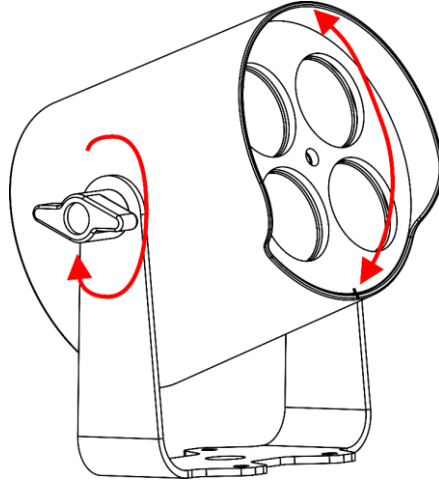

Fig. 06

4.5. Charging the Battery



DANGER
Risk of explosion caused by incorrect handling

This device contains a built-in rechargeable lithium-ion battery. The battery is not replaceable. The battery may explode or cause burns if it is crushed, disassembled or exposed to fire or high temperatures.

- Do not open the device and do not attempt to remove the built-in battery.

This device is delivered with an AC power adapter that is used to charge the battery. Before connecting the AC power adapter to the socket-outlet, make sure that the power supply matches the input voltage specified on the information label on the AC power adapter.

To charge the battery follow the steps bellow:

- 01) Put the device indoors to charge. Connect the AC power adapter to the device. Use only the AC power adapter delivered with the device.
- 02) Connect the AC power adapter to the socket-outlet.

During charging, a **C** on the display is blinking. When charging is completed, the display shows: 

- Charge the battery before using the device for the first time.
- Do not deep discharge the battery as this will shorten the battery's lifetime. Recharge the battery as early as possible. Do not let the light run until the battery is depleted.
- Make sure that the battery is charged to at least 50 % before storing the device.

It is recommended to charge the device at an ambient temperature between 0 °C and 35 °C.

If the device is charged in a carrying case, leave the case open.

Refer to **3.3. Product Specifications** on page 11 for the charge time of the battery.

5. Setup

5.1. Warnings and Precautions



DANGER
Electric shock caused by short-circuit

This device is IP65 rated.

- Do not expose the device to conditions that exceed the rated IP class conditions.
- Keep the connector sealed with the rubber cap when the connector is not in use.

5.2. Stand-alone Setup

The EventLITE 4/8 Mini Q4 functions as a stand-alone device.

For more information about the control modes, refer to **6.2. Control Modes** on page 17.

6. Operation

6.1. Safety Instructions for Operation



Attention

This device must be used only for the purposes it is designed for.

This device is intended for professional use as an outdoor spot. It is not suitable for households and for general lighting.

Any other use, not mentioned under intended use, is regarded as non-intended and incorrect use.



Attention

Power supply

Before connecting the device to the power supply, make sure that the current, voltage and frequency match the input voltage, current and frequency specified on the information label on the device.

6.2. Control Modes

The EventLITE 4/8 Mini Q4 can be operated as a stand-alone device.

The EventLITE 4/8 Mini Q4 supports the following control modes:

- Stand-alone: Auto, Built-in programs, Preset colors, Manual and Sound-controlled

To run the built-in programs:

- 01) Run all built-in programs in a sequence in Auto menu. See **6.6.1. Auto** on page 20 for more information.
- 02) Select one of the 16 built-in programs in Program menu. See **6.6.2. Built-in Programs** on page 20 for more information. Adjust the program speed and strobe frequency.

To run the preset colors:

Select one of the 39 preset colors in Program menu. See **6.6.2.1. Program 01** on page 20 for more information.

To operate the device manually as a stand-alone device:

- Adjust the colors in Static color control. See **6.6.3. Static color control** on page 21 for more information.

For more information about sound-controlled operation mode see **6.6.4. Sound-controlled mode** on page 21.

6.3. Control Panel

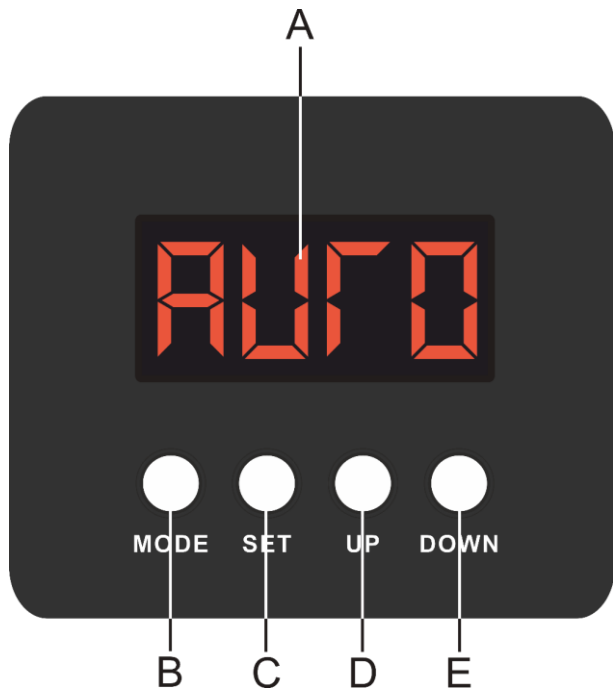

- A) LCD display
- B) MODE button
- C) SET button
- D) UP button
- E) DOWN button

Fig. 07

- Use the **MODE** button to exit the current submenu and to return to the Main Menu.
- Use the **UP/DOWN** buttons to navigate through the menus or to increase/decrease numeric values.
- Use the **SET** button to open the desired menu, to confirm your choice or to set the currently selected value.

6.4. Start-up

Upon start-up the display briefly shows its software version.

Note:

If no button is pressed after 30 seconds of inactivity, the display will turn off. Press any button to turn the display on.

6.5. Menu Overview

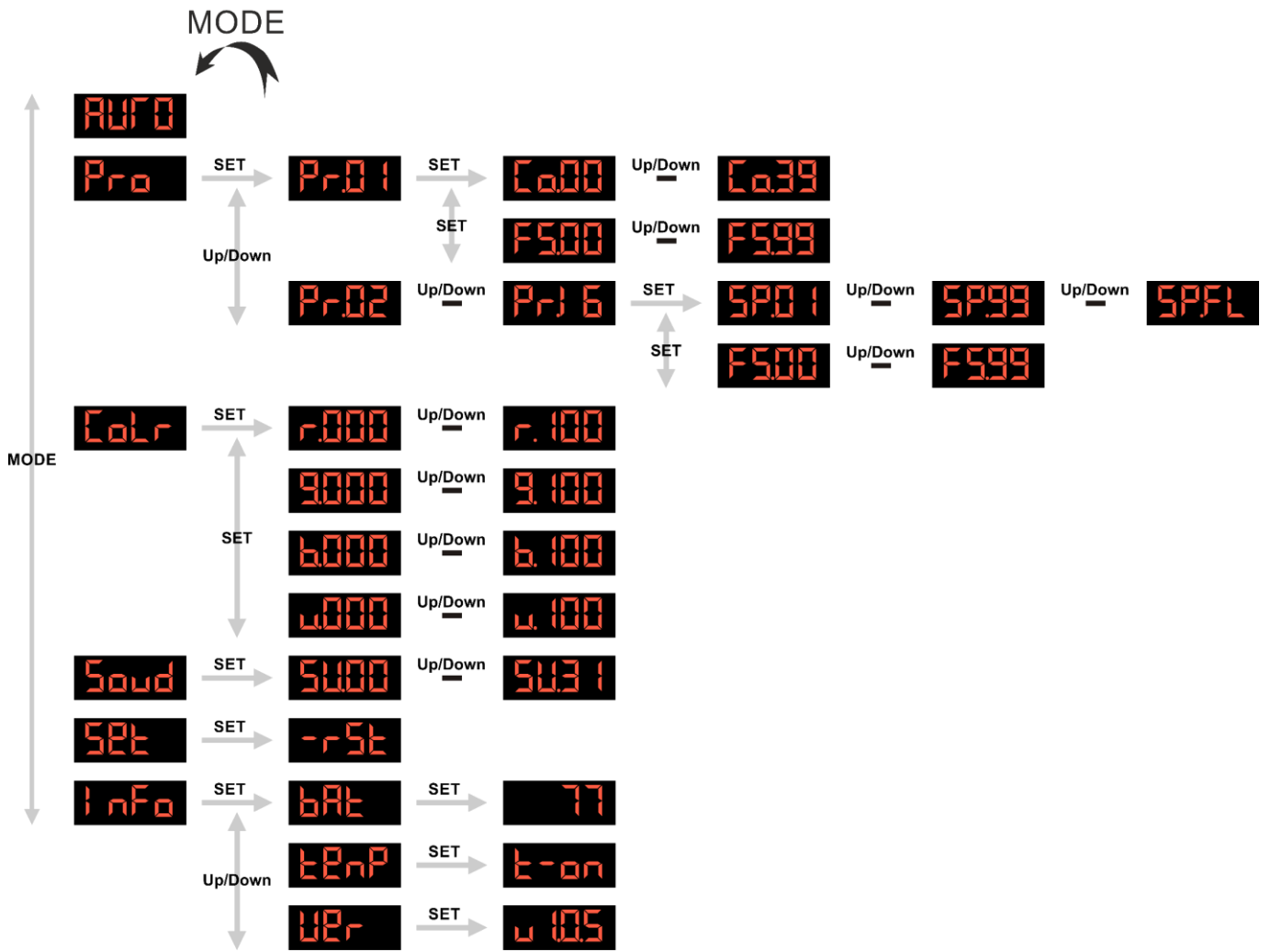

6.6. Main Menu Options

Upon start-up, the display shows the current software version.

v 1.05

The main menu has the following options:

AUTO

Auto program mode

Pro

Built-in programs

Colr

Static color control

Sound

Sound-controlled mode

SET

Settings

Info

Info

- Press the **MODE** or **UP/DOWN** buttons to navigate through the main menu.
- Press the **SET** button to open the menus.

6.6.1. Auto Mode

In this menu you can set the Auto mode.

While in the main menu, press the **MODE** button to select **AUTO**. The device immediately starts the Auto mode.

6.6.2. Built-in Programs

In this menu you can set the Built-in programs.

- 01) While in the main menu, press the **MODE** button to select **Pro**.
- 02) Press the **SET** button to open the menu.
- 03) Press the **UP/DOWN** buttons to select one of the following 2 options:

P-01

P-02

Up/Down

P-16

6.6.2.1. Program 01

- 01) If you select program 01, press the **SET** button to open the submenu and select one of the 2 options:
 - **CO01** COLOR
 - **FS00** STROBE
- 02) If you select CO01, press the **UP/DOWN** buttons to select one of the 39 color macros. CO00 is blackout
- 03) If you select FS00, press the **UP/DOWN** buttons to set the strobe frequency. The adjustment range is between 00–99, from OFF to high frequency.

6.6.2.2. Programs 02–16

01) If you select one of the programs 02–16, press the **SET** button to select one of the 2 options:

-  SPEED
-  STROBE

02) If you select SPEED, press the **UP/DOWN** buttons to set the built-in program's speed. The adjustment range is 01–100, from slow to fast.

03) If you select STROBE, press the **UP/DOWN** buttons to set the strobe frequency. The adjustment range is 00–99, from OFF to high frequency.

6.6.3. Static color control

In this menu you can manually set the desired colors.

01) While in the main menu, press the **MODE** button to select .

02) Press the **SET** button to enter the menu.

03) Press the **SET** button to select one of the following 4 options:



04) Press the **UP/DOWN** buttons to change the values. You can combine Red, Green, Blue and White to create an infinite range of colors (0-100).

   Gradual adjustment red (0-100)

   Gradual adjustment green (0-100)

   Gradual adjustment blue (0-100)

   Gradual adjustment white (0-1005)

6.6.4. Sound-controlled mode

In this menu you can set the sensitivity of the sound mode.

01) While in the main menu, press the **MODE** button to select .

02) Press the **SET** button to enter the menu.

03) Press the **UP/DOWN** buttons to set the sound sensitivity. The adjustment range is between 0–31.

6.6.5. Settings

In this menu you can restore the default factory settings.

- 01) While in the main menu, press the **MODE** button to select .
- 02) Press the **SET** button to enter the menu.
- 03) The display shows the following option:



- 04) Press the **SET** button to reset the device.

6.6.6. Info

In this menu you can view the battery level, the temperature and the current software version.

- 01) While in the main menu, press the **MODE** button to select .
- 02) Press the **SET** button to enter the menu.
- 03) Press the **UP/DOWN** buttons to select the following 3 options:



Battery level



Temperature



Software version

- 04) Press the **SET** button to open the submenu and view the additional information.

6.7. Remote Control

The device can be controlled with the included IR remote control.



DANGER
Do not ingest battery, chemical burn hazard

The remote control contains a coin cell battery. If the coin cell battery is swallowed, it can cause severe internal burns in just 2 hours and can lead to death.

The battery is already installed in the remote control. It is protected against discharge by a transparent plastic foil. Remove the plastic foil before using the remote control for the first time.

When replacing the battery, make sure that the polarity is correct. Incorrect polarity may damage the remote control.

You can control several devices at the same time with the remote control. Make sure that you point the remote control to the **infrared sensor (04)** of the device or group of devices that you want to control, as shown in Fig. 08. If you point the remote control to the **infrared sensor (04)** of the device outside of the range of the sensor, the device will not respond to the remote control (Fig. 09).

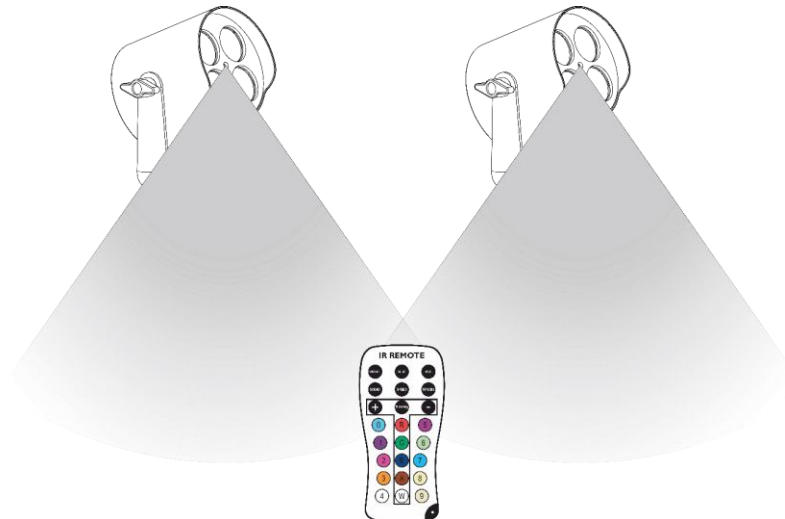

Fig. 08

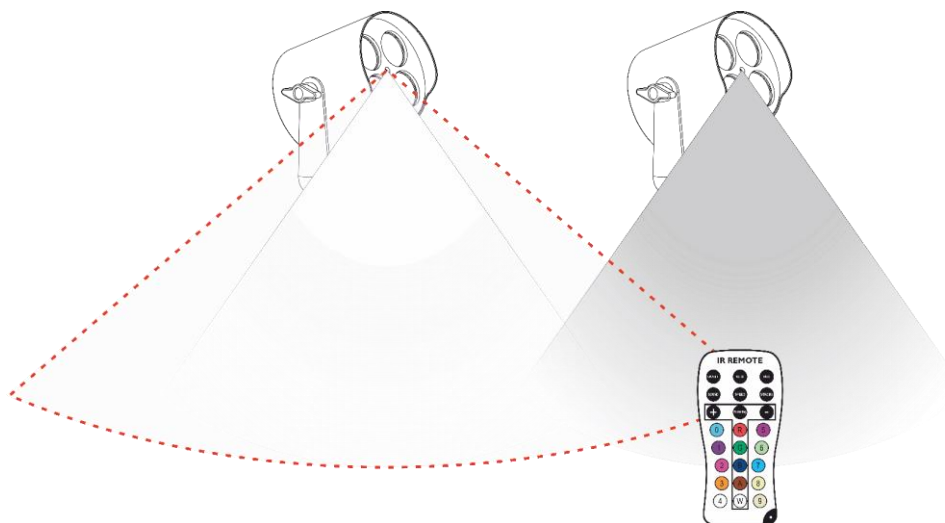

Fig. 09

To operate the device with the IR remote control, point the remote control to the **infrared sensor (04)**.

Note:

The remote control will work only if the device is already operating in Auto, Built-in Programs, Sound or Manual mode.

The remote control has the following functions:

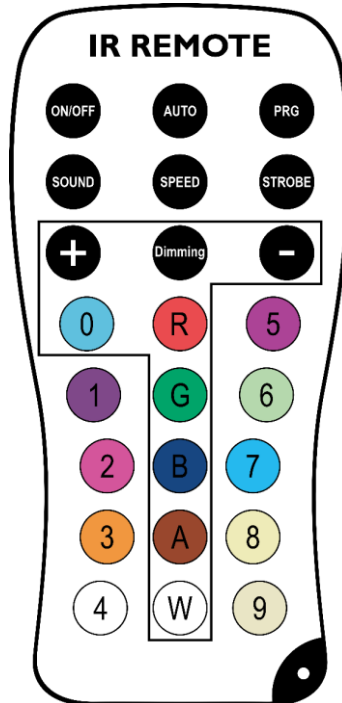

Fig. 10

Note:

When you turn off the device, the next time you turn it on, it will continue to operate in the previously selected operation mode.



| Button | Function | Description |
|---------|-----------------------|---------------------------------------|
| ON/OFF | On/Off | Turns the LEDs on/off |
| AUTO | Auto | Activates Auto mode |
| PRG | Program | Activates Built-in Programs mode |
| SOUND | Sound-controlled Mode | Activates Sound-controlled mode |
| SPEED | Speed | Activates program speed adjustment |
| STROBE | Strobe | Activates strobe frequency adjustment |
| Dimming | Dimming | Activates Manual mode |
| + | Plus | Increase value |
| - | Minus | Decrease value |

| Button | Function | Description |
|---|-------------|---|
|  | Red | Activates Red LEDs |
|  | Green | Activates Green LEDs |
|  | Blue | Activates Blue LEDs |
|  | Amber | Activates a mixed color to mimic Amber LEDs |
|  | White | Activates White LEDs |
|  | Cyan | Activates cyan color |
|  | Purple | Activates purple color |
|  | Purple/pink | Activates purple/pink color |
|  | Orange | Activates orange color |
|  | Cool white | Activates cool white color |
|  | Pink | Activates pink color |
|  | Light green | Activates light green color |
|  | Light blue | Activates light blue color |
|  | Yellow | Activates yellow color |
|  | Warm white | Activates warm white color |



6.7.1. Auto mode

Press the  button to activate Auto mode. The device runs its built-in programs in a sequence.



6.7.2. Built-in Programs

- 01) Press the  button to activate the Built-in Programs mode.
- 02) Press the  and  buttons to select one of the 16 built-in programs.

6.7.2.1. Sound-controlled mode

- 01) Press the  button to activate the Sound-controlled mode.
- 02) With the  and  buttons you can set the sensitivity between 00-31.



6.7.2.2. Program Speed

- 01) Press the  button to set the program speed.
- 02) Press the  and  buttons to increase/decrease the program speed. The adjustment range is 1–100, from slow to fast.







Note:

If you select program 1 and start adjusting the program speed, the device automatically switches to program 2. It is because the program speed function is available only in programs 2–16. The device searches for and activates the first following program that has the program speed function.





6.7.2.3. Strobe

- 01) Press the  button to set the strobe frequency.
- 02) Press the  and  buttons to increase/decrease the strobe frequency. The adjustment range is 0–99, from OFF to high strobe frequency.

6.7.3. Manual

- 01) Press the  button to activate Manual mode.
- 02) Press the , , ,  button to select one of the RGBW colors.
- 03) Press the  and  buttons to set the LED brightness of the selected color. The adjustment range is 0–255. You can combine Red, Green, Blue and White to create an infinite range of colors.

6.7.3.1. Color Presets

- 01) Press the  –  buttons to select the color presets.
- 02) Press the  and  buttons to select one of the 39 color presets.

7. Troubleshooting

This troubleshooting guide contains solutions to problems which can be carried out by an ordinary person. The device does not contain user-serviceable parts.

Unauthorized modifications to the device will render the warranty void. Such modifications may result in injuries and material damage.

Refer servicing to instructed or skilled persons. Contact your Highlite International dealer in case the solution is not described in the table.

| Problem | Probable cause(s) | Solution |
|---|---|--|
| The device does not function at all | No power to the device | <ul style="list-style-type: none"> • Check if power is switched on and cables are plugged in |
| | Internal fuse is blown | <ul style="list-style-type: none"> • Disconnect the device and contact your Highlite International dealer |
| The device does not respond to the remote control | The remote control is outside of the range of the sensor of the infrared port | <ul style="list-style-type: none"> • Walk closer to the device or change the angle at which you point the remote control to the device. See 6.7. Remote Control on page 23 |
| | The battery of the remote control is depleted | <ul style="list-style-type: none"> • Change the battery of the remote control |
| No light or LEDs cut out intermittently | LEDs are damaged | <ul style="list-style-type: none"> • Disconnect the device and contact your Highlite International dealer |
| | The power supply settings do not match local AC voltage and frequency | <ul style="list-style-type: none"> • Disconnect the device. Check the settings and correct, if necessary |

8. Maintenance

8.1. Safety Instructions for Maintenance



DANGER
Electric shock caused by dangerous voltage inside

Disconnect power supply before servicing or cleaning.

8.2. Preventive Maintenance



Attention
Before each use, examine the device visually for any defects.

Make sure that:

- All screws used for installing the device or parts of the device are tightly fastened and are not corroded.
- The safety devices are not damaged.
- There are no deformations on housings, fixations and installation points.
- The lens is not cracked or damaged.
- The power cables are not damaged and do not show any material fatigue.

8.2.1. Basic Cleaning Instructions

The external lens of the device must be cleaned periodically in order to optimize the light output. The cleaning schedule depends on the conditions at the site where the device is installed. When smoke or fog machines are used at the site, the device will need more frequent cleaning. On the other hand, if the device is installed in well-ventilated area, it will need less frequent cleaning. To establish a cleaning schedule, examine the device at regular intervals during the first 100 hours of operation.

To clean the device, follow the steps below:

- 01) Disconnect the device from the electrical power supply.
- 02) Allow the device to cool down for at least 15 minutes.
- 03) Remove the dust collected on the external surface with dry compressed air and a soft brush.
- 04) Clean the lens with a damp cloth. Use a mild detergent solution.
- 05) Dry the lens carefully with a lint-free cloth.
- 06) Clean the DMX and other connections with a damp cloth.



Attention

- Do not immerse the device in liquid.
- Do not use alcohol or solvents.
- Make sure that the connections are fully dry before connecting the device to the power supply and to other devices.

8.2.2. Draining Condensation Water

The EventLITE 4/8 Mini Q4 is IP65 rated. The device can resist water jets. If the device is exposed to extreme humid conditions during servicing, condensation may collect inside the device. This can happen also during transportation, if the device is exposed to extreme temperature variations.

If condensation water collects inside the device, follow the steps bellow to remove the condensation water:

01) Carefully remove the **protective valve (08)** with a wrench (16 mm).

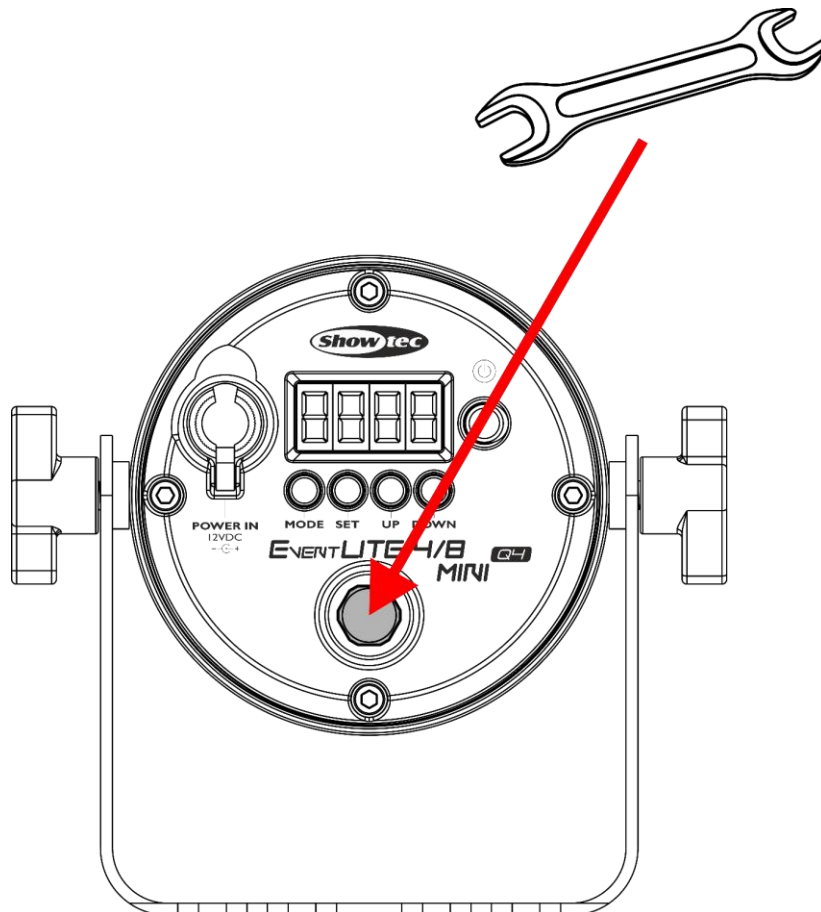

Fig. 11

02) Let the device operate at full output for 60 minutes.

03) Let the device cool down for 30 minutes.

04) Install the **protective valve (08)** back in place. Make sure that you do not overtighten it.

8.3. Corrective Maintenance

The device does not contain user-serviceable parts. Do not open the device and do not modify the device.

Refer repairs and servicing to instructed or skilled persons. Contact your Highlite International dealer for more information.

9. Deinstallation, Transportation and Storage

9.1. Instructions for Deinstallation



WARNING

Incorrect deinstallation can cause serious injuries and damage of property.

- Let the device cool down before dismounting.
- Disconnect power supply before deinstallation.
- Always observe the national and site-specific regulations during deinstallation and derigging of the device.
- Wear personal protective equipment in compliance with the national and site-specific regulations.

9.2. Instructions for Transportation

- Use the original packaging to transport the device, if possible.
- Always observe the handling instructions printed on the outer carton box, for example: "Handle with care", "This side up", "Fragile".

9.3. Storage

- Clean the device before storing. Follow the cleaning instructions in chapter **8.2.1. Basic Cleaning Instructions** on page 28.
- Store the device in the original packaging, if possible.

10. Disposal

Correct disposal of this product

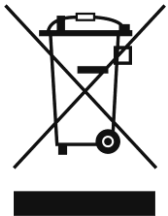

Waste Electrical and Electronic Equipment

This symbol on the product, its packaging or documents indicates that the product shall not be treated as household waste. Dispose of this product by handing it to the respective collection point for recycling of electrical and electronic equipment. This is to avoid environmental damage or personal injury due to uncontrolled waste disposal. For more detailed information about recycling of this product contact the local authorities or the authorized dealer.

11. Approval



Check the respective product page on the website of Highlite International (www.highlite.com) for an available declaration of conformity.



©2023 Showtec