

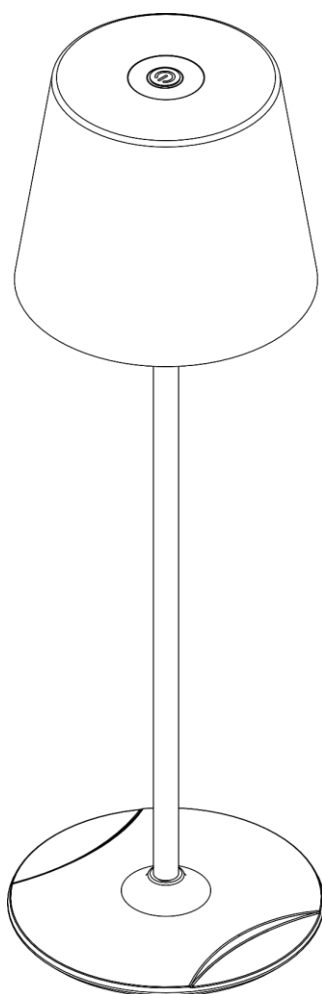

USER MANUAL



ENGLISH

EventLITE Table RGBW

V1

Product code: 44030 – White housing
44031 – Black housing
44032 – Bronze housing

Preface

Thank you for purchasing this Showtec product.

The purpose of this user manual is to provide instructions for the correct and safe use of this product.

Keep the user manual for future reference as it is an integral part of the product. The user manual shall be stored at an easily accessible location.

This user manual contains information concerning:

- Safety instructions
- Intended and non-intended use of the device
- Installation and operation of the device
- Maintenance procedures
- Troubleshooting
- Transport, storage and disposal of the device

Non-observance of the instructions in this user manual may result in serious injuries and damage of property.

©2022 Showtec. All rights reserved.

No part of this document may be copied, published or otherwise reproduced without the prior written consent of Highlite International.

Design and product specifications are subject to change without prior notice.

For the latest version of this document or for other language versions, please visit our website www.highlite.com or contact us at service@highlite.com.

Highlite International and its authorized service providers are not liable for any injury, damage, direct or indirect loss, consequential or economic loss or any other loss arising from the use of, or inability to use or reliance on the information contained in this document.

Table of contents

| | |
|--|-----------|
| 1. Introduction | 4 |
| 1.1. Before Using the Product | 4 |
| 1.2. Intended Use | 4 |
| 1.3. LEDs Lifespan | 4 |
| 1.4. Text Conventions | 4 |
| 1.5. Symbols and Signal Words..... | 5 |
| 1.6. Symbols on the Information Label | 5 |
| 2. Safety | 6 |
| 2.1. Warnings and Safety Instructions | 6 |
| 2.2. Requirements for the User..... | 7 |
| 3. Description of the Device | 8 |
| 3.1. Front View | 8 |
| 3.2. Bottom View | 9 |
| 3.3. Product Specifications | 10 |
| 3.4. Optional Accessories..... | 11 |
| 3.5. Dimensions..... | 11 |
| 4. Installation | 12 |
| 4.1. Installation Site Requirements | 12 |
| 4.2. Replacing the Lamp Stem..... | 12 |
| 4.3. Attaching a Larger Baseplate | 13 |
| 4.4. Charging the Battery | 14 |
| 4.5. Battery LED Indicator Statuses | 14 |
| 5. Setup | 15 |
| 5.1. Stand-alone Setup | 15 |
| 5.2. Wi-Fi Connection | 15 |
| 5.2.1. Wi-Fi Connection of a Single Device | 15 |
| 5.2.2. Wi-Fi Connection of Multiple Devices..... | 16 |
| 5.2.3. Wi-Fi LED Indicator Statuses | 16 |
| 5.3. Supported Control Protocols | 17 |
| 5.3.1. DMX Addressing..... | 17 |
| 5.3.2. Universe Numbering..... | 18 |
| 6. Operation | 19 |
| 6.1. Safety Instructions for Operation | 19 |
| 6.2. Turning On/Off | 19 |
| 6.3. Hotspot Mode | 19 |
| 6.4. Factory Reset | 19 |
| 6.5. Control Modes | 20 |
| 6.6. Manual Control..... | 20 |
| 6.6.1. Functions of the Manual Control Button | 20 |
| 6.6.1.1. Switching on the Device..... | 20 |
| 6.6.1.2. Switching off the Device..... | 20 |
| 6.6.1.3. Battery Status Check | 20 |
| 6.6.1.4. Navigation | 21 |
| 6.6.1.5. Switching between Operation Modes..... | 21 |
| 6.6.2. Operation Modes | 21 |
| 6.6.2.1. Auto Mode | 21 |
| 6.6.2.2. Built-in Programs | 22 |
| 6.6.2.3. Static Colors | 22 |
| 6.6.2.4. Dimming Mode..... | 22 |
| 6.6.2.5. DMX Mode..... | 22 |
| 6.7. Remote Control | 23 |
| 6.7.1. Functions of the Remote Control Buttons | 24 |
| 6.7.2. Operation Modes | 24 |

| | | |
|------------|--|-----------|
| 6.7.2.1. | Auto Mode | 25 |
| 6.7.2.2. | Built-in Programs | 25 |
| 6.7.2.3. | Static Colors | 25 |
| 6.7.2.4. | Dimming Mode..... | 25 |
| 6.8. | Control via the Web Interface..... | 26 |
| 6.8.1. | Wi-Fi Setup..... | 26 |
| 6.8.2. | Setup Devices | 27 |
| 6.8.2.1. | Auto Mode | 28 |
| 6.8.2.2. | Built-in Programs | 29 |
| 6.8.2.3. | Static Colors | 30 |
| 6.8.2.4. | Dimming Mode..... | 30 |
| 6.8.2.5. | DMX Mode..... | 31 |
| 6.8.3. | Art-Net Configuration | 32 |
| 6.8.4. | sACN Configuration | 32 |
| 6.9. | DMX Channels | 33 |
| 6.9.1. | DMX Channels Overview | 33 |
| 6.9.2. | 1 Channel, 2 Channels | 33 |
| 6.9.3. | 4 Channels, 5 Channels, 6 Channels, 9 channels | 34 |
| 7. | Troubleshooting | 36 |
| 8. | Maintenance | 37 |
| 8.1. | Preventive Maintenance | 37 |
| 8.1.1. | Basic Cleaning Instructions | 37 |
| 8.2. | Corrective Maintenance | 37 |
| 9. | Transportation and Storage..... | 38 |
| 9.1. | Instructions for Transportation | 38 |
| 9.2. | Storage | 38 |
| 10. | Disposal | 38 |
| 11. | Approval..... | 38 |

1. Introduction

1.1. Before Using the Product



Important

Read and follow the instructions in this user manual before installing, operating or servicing this product.

The manufacturer will not accept liability for any resulting damages caused by the non-observance of this manual.

After unpacking, check the contents of the box. If any parts are missing or damaged, contact your Highlite International dealer.

Your shipment includes:

- Showtec EventLITE Table RGBW
- USB Type A to USB Type C cable, 1 m
- User manual

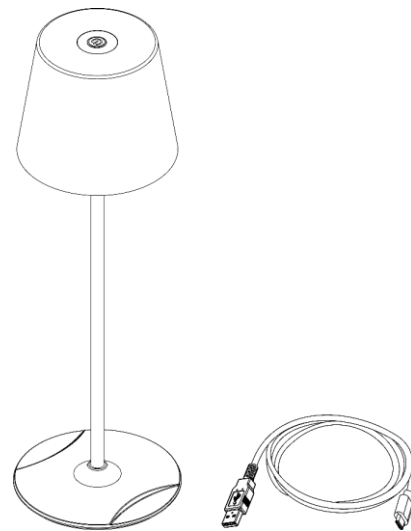

Fig. 01

1.2. Intended Use

This device is designed to be used as a decorative battery-powered table luminaire, suitable for the hospitality industry. This device is not suitable for households and for general lighting.

Any other use, not mentioned under intended use, is regarded as non-intended and incorrect use.

1.3. LEDs Lifespan

The light output of the LEDs gradually decreases over time (lumen depreciation). High operating temperatures contribute to this process. You can extend the lifespan of the LEDs by providing adequate ventilation and operating the LEDs at the lowest possible brightness.

1.4. Text Conventions

Throughout the user manual the following text conventions are used:

- Buttons: All buttons, and interface sliders and fields are in bold lettering, for example "Slide the **Strobe** slider", "Enter the DMX starting address in the **Address** field"
- References: References to chapters and parts of the device are in bold lettering, for example: "Refer to **2. Safety**", "set **the power switch (14)** to on position"
- 0–255: Defines a range of values
- Notes: **Note:** (in bold lettering) is followed by useful information or tips

1.5. Symbols and Signal Words

Safety notes and warnings are indicated throughout the user manual by safety signs.

Always follow the instructions provided in this user manual.



DANGER

Indicates an imminently hazardous situation which, if not avoided, will result in death or serious injury.



WARNING

Indicates a potentially hazardous situation which, if not avoided, could result in death or serious injury.



CAUTION

Indicates a potentially hazardous situation, which, if not avoided, may result in minor or moderate injury.



Attention

Indicates important information for the correct operation and use of the product.



Important

Read and observe the instructions in this document.



Provides important information about the disposal of this product.



1.6. Symbols on the Information Label

This product is provided with an information label. The information label is located on the bottom of the baseplate of the device.

The information label contains the following symbols:



This device shall not be treated as household waste.



This device falls under IEC protection class III.



Read the user manual supplied with the device.



This device contains a battery.

2. Safety



Important

Read and follow the instructions in this user manual before installing, operating or servicing this product.

The manufacturer will not accept liability for any resulting damages caused by the non-observance of this manual.

2.1. Warnings and Safety Instructions



DANGER

Danger for children

For adult use only. The device must be installed beyond the reach of children.

- Do not leave various parts of the packaging (plastic bags, polystyrene foam, nails, etc.) within children's reach. Packaging material is a potential source of danger for children.



DANGER

Risk of explosion caused by incorrect handling

This device contains a built-in rechargeable lithium-ion battery. The battery is not replaceable. The battery may explode or cause burns if it is crushed, disassembled or exposed to fire or high temperatures.

- Do not open the device and do not attempt to remove the built-in battery.
- Do not disassemble the battery.
- Do not crush or puncture the battery.
- Do not short-circuit the battery.
- Do not expose the battery to water or other liquids.
- Keep the battery away from fire and heat.



WARNING

Risk of epileptic shock

Strobe lighting can trigger seizures in photosensitive epilepsy. Sensitive persons should avoid looking at strobe lights.



Attention

Power supply

Before connecting the device to the power supply, make sure that the input current, voltage and frequency of the device match the voltage, current and frequency specified on the information label on the USB power adapter.



Attention **General safety**

- Do not shake the device. Avoid brute force when installing or operating the device.
- If the device is exposed to extreme temperature variations (e.g. after transportation), do not switch it on immediately. Let the device reach room temperature before switching it on, otherwise it may be damaged by the formed condensation.
- If the device fails to work properly, discontinue the use immediately.



Attention **This device shall be used only for the purposes it is designed for.**

This device is designed to be used as a decorative battery-powered table luminaire, suitable for the hospitality industry. Any incorrect use may lead to hazardous situations and result in injuries and material damage.

- This device is not suitable for households and for general lighting.
- This device does not contain user-serviceable parts. Unauthorized modifications to the device will render the warranty void. Such modifications may result in injuries and material damage.



Attention **Do not expose the device to conditions that exceed the rated IP class conditions.**

The device is IP23 rated. IP (Ingress Protection) 23 class provides protection against solid objects greater than 12 mm, such as fingers, and water falling as a spray at an angle of up to 60° from the vertical.

2.2. Requirements for the User

This product may be used by ordinary persons. Maintenance and installation may be carried by ordinary persons. Service shall be carried out only by instructed or skilled persons. Contact your Highlite International dealer for more information.

Instructed persons have been instructed and trained by a skilled person, or are supervised by a skilled person, for specific tasks and work activities associated with the installation, service and maintenance of this product, so that they can identify risks and take precautions to avoid them.

Skilled persons have training or experience, which enables them to recognize risks and to avoid hazards associated with the installation, service and maintenance of this product.

Ordinary persons are all persons other than instructed persons and skilled persons. Ordinary persons include not only users of the product but also any other persons that may have access to the device or who may be in the vicinity of the device.

3. Description of the Device

The Showtec EventLITE Table RGBW is a battery-powered LED table lamp. It is suitable for use in the hospitality industry. The EventLITE Table RGBW can be controlled manually, via Wi-Fi and via a remote control.

3.1. Front View

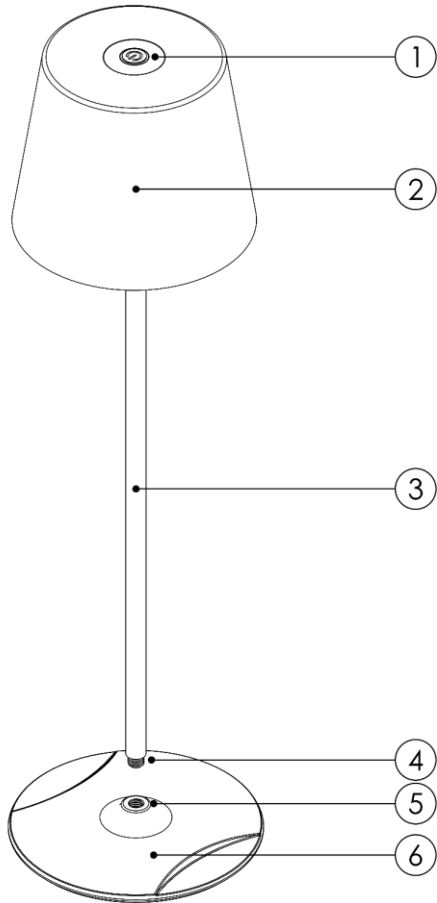

- 01) Manual control button
- 02) Lamp head
- 03) Lamp stem
- 04) Thread, M8
- 05) Threaded opening, M8
- 06) Baseplate

Fig. 02

3.2. Bottom View

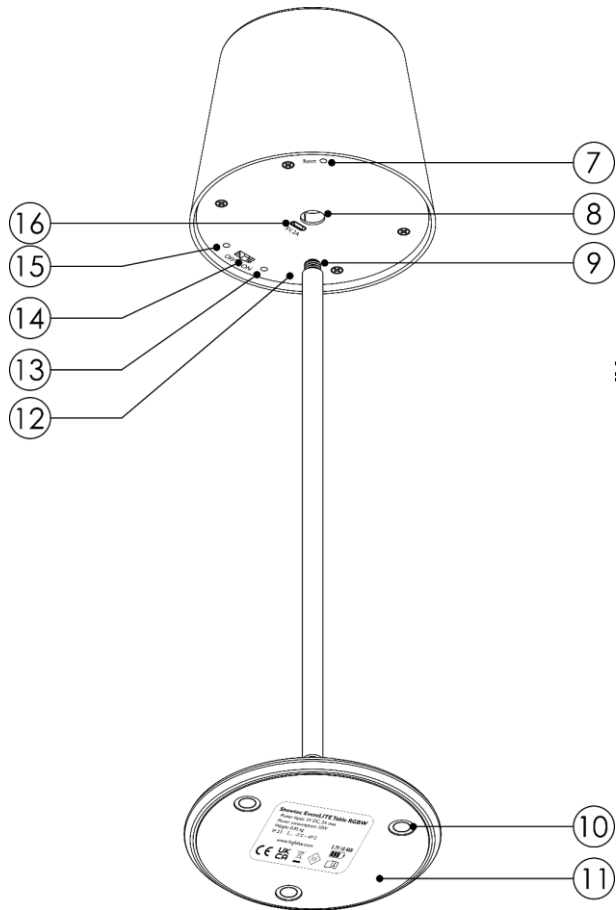

- 07) Reset button
- 08) Threaded opening, M8
- 09) Thread, M8
- 10) 3 x Magnets
- 11) Anti-slip rubber pad
- 12) Infrared port
- 13) Wi-Fi LED indicator
- 14) Power switch, ON/OFF
- 15) Battery LED indicator
- 16) USB-C connector IN, 5 V, 2 A

g. 03

3.3. Product Specifications

| | |
|-------------------------------------|--|
| Model: | EventLITE Table RGBW |
| Electrical: | |
| Power input: | 5 V DC, 2 A |
| Power consumption: | 10 W |
| Physical: | |
| Dimensions: | Ø 124 x 385 mm (D x H) |
| Weight: | 0,95 kg |
| Optics: | |
| Light source: | 12 x 2 W RGBW LEDs |
| Luminous flux: | 144 lm |
| CCT: | 3100 K |
| CRI: | 85 |
| Refresh rate: | 1000 Hz |
| Dimmer: | 0–100 % |
| Strobe: | 0–20 Hz |
| Beam angle: | 65° circular |
| Life expectancy: | 30000 h |
| Operation and control: | |
| Control: | Manual, IR remote, wireless |
| Control protocols: | DMX over Art-Net/sACN |
| DMX personalities: | 6 (1, 2, 4, 5, 6, 9 channels) |
| Display: | No |
| Wireless module: | 2,4 GHz |
| Battery: | |
| Type: | Sealed lithium-ion battery |
| Capacity: | 10400 mA·h |
| Voltage: | 3,7 V |
| Watt-hour rating: | 37 W·h |
| Runtime: | 8 hours (at full output) / 16 hours (average) |
| Charge time: | 10 h |
| Battery lifetime: | 400 discharge cycles (battery runtime drops at 70 %) |
| Connections: | |
| Power connections: | USB-C connector IN, 5 V DC, 2 A |
| Construction: | |
| Housing: | Aluminum die-cast |
| Color: | 44030 – White housing 44031 – Black housing 44032 – Bronze housing |
| IP rating: | IP23 |
| Cooling: | Convection |
| Thermal: | |
| Minimum ambient temperature t_a : | -5 °C |
| Maximum ambient temperature t_a : | 45 °C |
| Charging temperature range: | 0–35 °C |
| Storage temperature range: | 5–20 °C |

3.4. Optional Accessories

The EventLITE Table RGBW can be fitted with a 50-cm extension pole and secured with a larger baseplate. The extension pole and the larger baseplate are not supplied with the device. You can purchase these accessories with any Highlite International dealer.

- Product code: [44036](#) EventLITE baseplate 30 cm, white
- Product code: [44037](#) EventLITE Table extension pole 50 cm, white
- Product code: [44038](#) EventLITE Table extension pole 50 cm, black
- Product code: [44039](#) EventLITE Table extension pole 50 cm, bronze

3.5. Dimensions

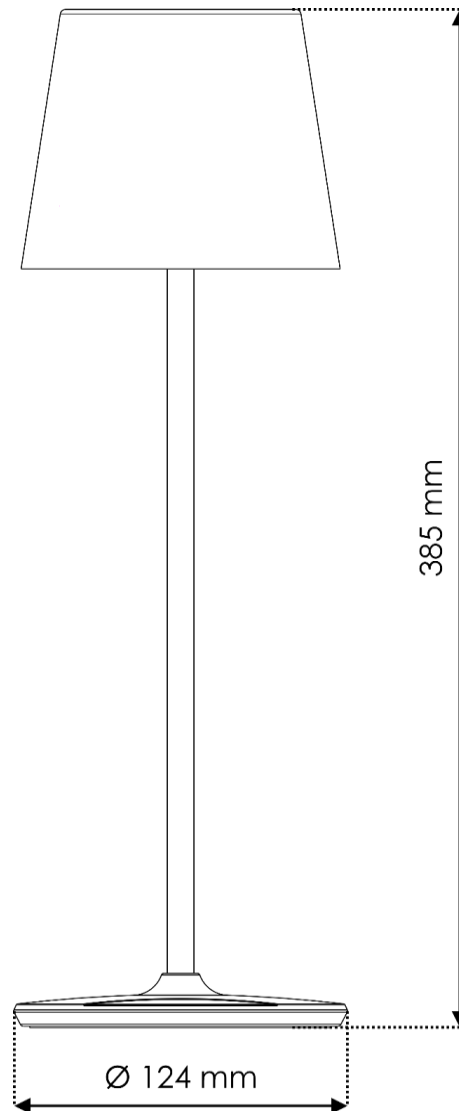

Fig. 04

4. Installation

4.1. Installation Site Requirements

The device must be used only indoors. It must be placed on a flat surface.

- The device must be placed away from heating sources and direct sunlight.
- The minimum ambient temperature $t_a = -5\text{ °C}$ and the maximum ambient temperature $t_a = 45\text{ °C}$ must never be exceeded.
- The relative humidity must not exceed 50 % with an ambient temperature of 45 °C.

Note:

It is recommended to charge the device at an ambient temperature between 0 °C and 35 °C.

4.2. Replacing the Lamp Stem

The **lamp stem (03)** of the EventLITE Table RGBW is a threaded rod and can be easily replaced. The optional extension pole is not supplied with the device. For more information see **3.4. Optional Accessories** on page 11.

To replace the **lamp stem (03)**, follow the steps below:

- 01) Turn the **lamp head (02)** counterclockwise to remove it from the **lamp stem (03)**, as shown in Fig. 05.
- 02) Turn the **baseplate (06)** counterclockwise to remove it from the **lamp stem (03)**, as shown in Fig. 05.
- 03) Insert one end of the extension pole into the **threaded opening (08)** on the **lamp head (02)** and turn it clockwise to fit it in position.
- 04) Insert the other end of the extension pole into the **threaded opening (05)** on the **baseplate (06)** and turn it clockwise to fit it in position.

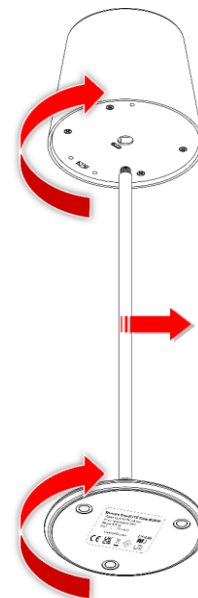

Fig. 05

4.3. Attaching a Larger Baseplate

To increase the stability of the EventLITE Table RGBW you can attach a larger baseplate below the surface where the device is placed on, or under a tablecloth, for example. See Fig. 06 for more information.

The EventLITE Table RGBW has 3 **magnets (10)** on the **baseplate (06)**, that hold the device to the metal surface of the larger baseplate. The 30-cm baseplate is not supplied with the device. For more information see **3.4. Optional Accessories** on page 11.

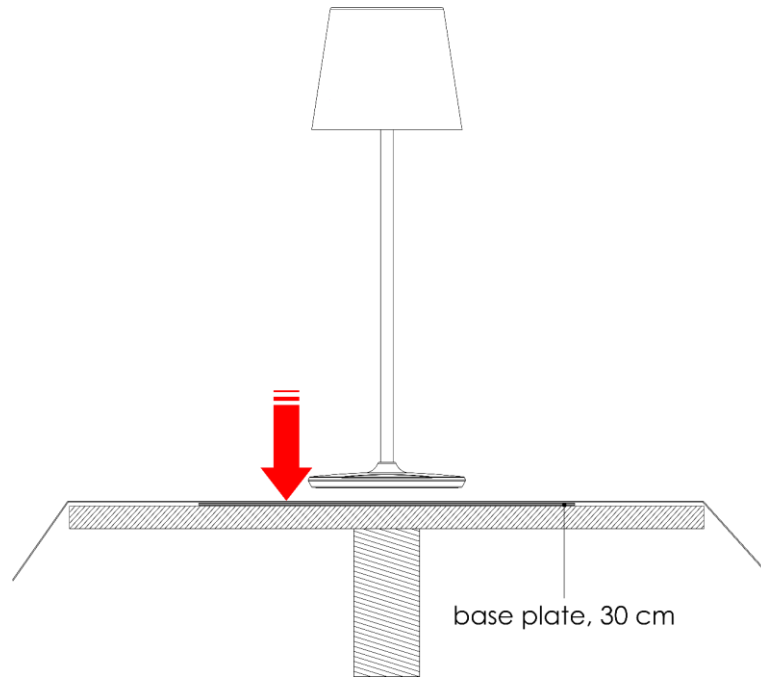

Fig. 06

4.4. Charging the Battery



DANGER
Risk of explosion caused by incorrect handling

This device contains a built-in rechargeable lithium-ion battery. The battery is not replaceable. The battery may explode or cause burns if it is crushed, disassembled or exposed to fire or high temperatures.

- Do not open the device and do not attempt to remove the built-in battery.
- Do not crush or puncture the battery.

This device is supplied with a USB cable, that is used to charge the battery.

To charge the battery follow the steps below:

- 01) Turn on the device from the **power switch (14)**.
- 02) Connect the USB-C connector of the supplied USB cable to the **USB-C connector IN (16)** of the device.
- 03) Connect the USB-A connector of the supplied USB cable to a USB power adapter or to a power sourcing equipment (a personal computer or a similar device).
- 04) Connect the USB power adapter to the socket-outlet or switch on the power sourcing equipment.

During charging the **battery LED indicator (15)** is flashing. When charging is completed, the **battery LED indicator (15)** lights up. See **4.5. Battery LED Indicator Statuses** on page 14 for more information.





Notes:

- Charge the battery before using the device for the first time.
- Do not deep discharge the battery as this will shorten the battery's lifetime. Recharge the battery as early as possible. Do not let the light run until the battery is depleted.
- Make sure that the battery is charged to at least 50 % before storing the device.
- Charge the device at an ambient temperature between 0 °C and 35 °C.
- If the device is charged in a carrying case, leave the case open.

Refer to **3.3. Product Specifications** on page 10 for the charge time of the battery.

4.5. Battery LED Indicator Statuses

The **battery LED indicator (15)** shows the battery status:

| LED color | LED behavior | Battery is charged |
|--|--------------|--------------------|
|  Red | Flashing | 0–5 % |
|  Red | Lights up | 6–25 % |
|  Yellow | Lights up | 26–50 % |
|  Blue | Lights up | 51–75 % |
|  Green | Lights up | 76–100 % |

During charging the **battery LED indicator (15)** is flashing. When charging is completed, the **battery LED indicator (15)** lights up.

Note:

The **battery LED indicator (15)** can be set to turn off after 30 seconds of inactivity. See **6.8.2. Setup Devices** on page 27 for more information.

5. Setup

5.1. Stand-alone Setup

When the EventLITE Table RGBW is not connected to a controller or to other devices, it functions as a stand-alone device. It can be operated manually or with an infrared (IR) remote control.

For more information about the control modes, refer to **6.5. Control Modes** on page 20.

5.2. Wi-Fi Connection

The EventLITE Table RGBW can be connected to a personal computer with a wireless module.

5.2.1. Wi-Fi Connection of a Single Device

To connect a single device to a personal computer, follow the steps below:

- 01) Turn on the device from the **power switch (14)**. The device will enter into hotspot mode. See **6.3. Hotspot Mode** on page 19 for more information.
- 02) Turn on the Wi-Fi on the personal computer.
- 03) Open the list with available Wi-Fi networks on the personal computer.
- 04) Select "EventLite#X" from the list. "X" in the name stands for the universe number.
- 05) Connect to "EventLite#X". The password is "eventlite".

Note:

If you do not see the device on the list with available networks, you need to reset the device to its factory settings. See **6.4. Factory Reset** on page 19 for more information.

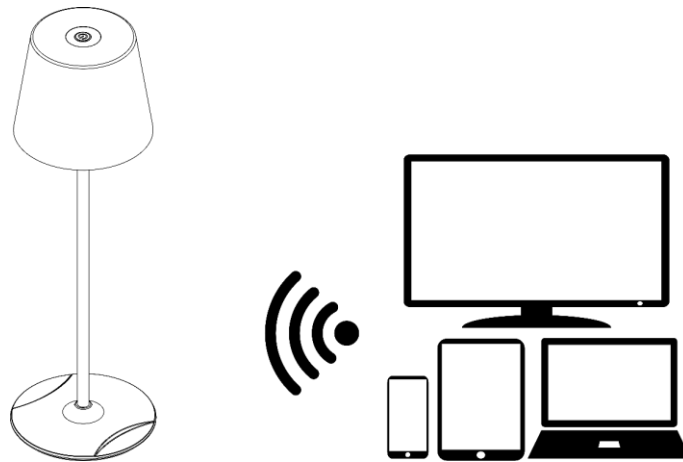

Fig. 07

5.2.2. Wi-Fi Connection of Multiple Devices

To connect multiple devices to a personal computer, you need a router. Follow the steps below to connect the devices:

- 01) Do not turn on all devices at the same time.
- 02) Connect the first device to the personal computer. See **5.2.1. Wi-Fi Connection of a Single Device** on page 15 for more information.
- 03) Configure the device and connect it to the router. See **6.8.1. Wi-Fi Setup** on page 26 for more information.
- 04) Turn off the first device from the **power switch (14)**.
- 05) Connect the second device to the personal computer. See **5.2.1. Wi-Fi Connection of a Single Device** on page 15 for more information.
- 06) Repeat steps 2–4 to connect and configure the rest of the devices.

Note:

The number of devices, that you can connect and control at the same time via Wi-Fi, depends on the bandwidth of the router and on the total number of all connected devices.

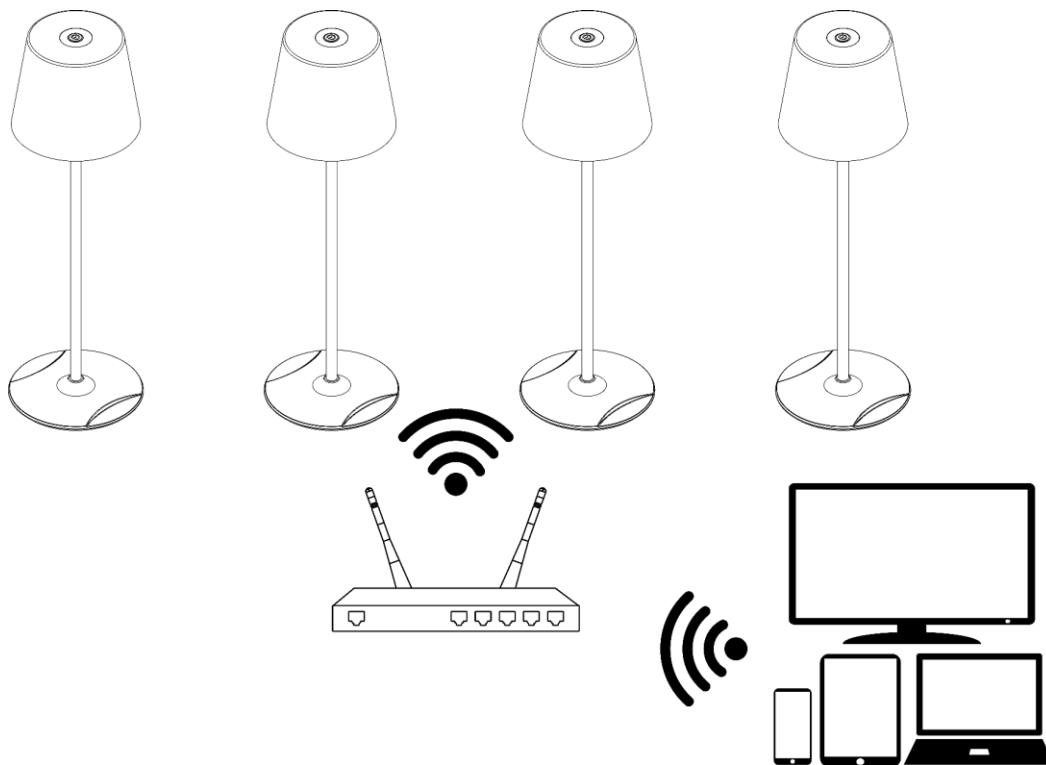

Fig. 08

5.2.3. Wi-Fi LED Indicator Statuses

The **Wi-Fi LED indicator (13)** has the following statuses:

- Always on: good Wi-Fi signal
- Flashing (100 ms): poor Wi-Fi signal
- Flashing (200 ms): connecting to router
- Flashing (500 ms): initiating Wi-Fi signal
- Off: no signal or in hotspot mode (see **6.3. Hotspot Mode** on page 19)

Note:

The **Wi-Fi LED indicator (13)** can be set to turn off after 30 seconds of inactivity. See **6.8.2. Setup Devices** on page 27 for more information.

5.3. Supported Control Protocols

The EventLITE Table RGBW supports DMX via Art-Net and sACN.

Art-Net is a protocol that uses TCP/IP to transfer large amount of DMX-512 data over an Ethernet network. Art-Net 4 can support up to 32768 universes. Art-Net™ Designed by and Copyright Artistic Licence Holdings Ltd.

sACN (streaming Architecture for Control Networks), also known as ANSI E1.31, is a protocol for sending DMX-512 data over IP networks developed by ESTA (Entertainment Services and Technology Association). It supports up to 63999 universes and uses multicasting.

5.3.1. DMX Addressing

In a setup with multiple devices, make sure that you set the DMX starting address of each device correctly. The EventLITE Table RGBW has 6 personalities: 1, 2, 4, 5, 6, and 9 channels.

If you want to connect multiple devices on one data link and control them separately in 9-channel mode, for example, follow the steps below:

- 01) Set the starting address of the 1st device on the data link to 1.
- 02) Set the starting address of the 2nd device on the data link to 10, as $1 + 9 = 10$.
- 03) Set the starting address of the 3rd device on the data link to 19 as $10 + 9 = 19$.
- 04) Continue assigning the starting addresses of the remaining devices by adding each time 9 to the previous number.

If you want to connect multiple devices on one data link and control them in the same way, set the same DMX starting address for all devices in the setup.

5.3.2. Universe Numbering

The number of devices that you can control on one data link is limited by the combined number of the DMX channels of the connected devices and the 512 channels available in one DMX universe.

After the limit of 512 channels is reached, the next device should be set to a universe with a higher number.

There are 512 channels (1–512) in one universe. 16 consecutive universes (0–15) make up one sub-net. 16 sub-nets (0–15) make up one net. There are in total 128 nets (0–127).

Note:

- In Art-Net, universes are called Port Address and number from 0 to 32767. There are 32768 unique numbers.
- In sACN, universes number from 1 to 63999. There are 64000 unique numbers. The values of 0 and 64000 to 65535 are reserved for future expansion according to the standard.

| 15-bit Port Address | Net (0–127) | Sub-net (0–15) | Universe (0–15) |
|---------------------|-------------|----------------|-----------------|
| 0 | 0 | 0 | 0 |
| 1 | 0 | 0 | 1 |
| 2 | 0 | 0 | 2 |
| ... | ... | ... | ... |
| 31 | 0 | 1 | 15 |
| 32 | 0 | 2 | 0 |
| 33 | 0 | 2 | 1 |
| ... | ... | ... | ... |
| 126 | 0 | 7 | 14 |
| 127 | 0 | 7 | 15 |
| 128 | 0 | 8 | 0 |
| ... | ... | ... | ... |
| 255 | 0 | 15 | 15 |
| 256 | 1 | 0 | 0 |
| 257 | 1 | 0 | 1 |
| ... | ... | ... | ... |
| 32766 | 127 | 15 | 14 |
| 32767 | 127 | 15 | 15 |

Note:

If you are using an Art-Net controller that supports Art-Net I or Art-Net II, the Art-Net net must be set to 0. The net number is available in Art-Net 3 and higher versions of the Art-Net protocol.

6. Operation

6.1. Safety Instructions for Operation



Attention

This device must be used only for the purposes it is designed for.

This device is designed to be used as a decorative battery-powered table luminaire, suitable for the hospitality industry. This device is not suitable for households and for general lighting.

Any other use, not mentioned under intended use, is regarded as non-intended and incorrect use.

6.2. Turning On/Off

The device has a power switch.

- Set the **power switch (14)** to ON position to turn on the device.
- Set the **power switch (14)** to OFF position to turn off the device.

Make sure that the device is turned off from the **power switch (14)** when the device is not in use. This will prevent the battery from depletion.

It is recommended to reset the device to its factory settings after each setup or use. See **6.4. Factory Reset** on page 19 for more information. When you turn off the device, the next time you turn it on, it will continue to operate in the previously selected operation mode.

6.3. Hotspot Mode

When you start the device for the first time, it enters by default in hotspot mode. When the device is in hotspot mode, you can establish a Wi-Fi connection with a personal computer. The IP address of the device in hotspot mode is 192.168.4.1.

To activate hotspot mode, you need to reset the device to the factory settings. See **6.4. Factory Reset** on page 19 for more information.

In hotspot mode the **Wi-Fi LED indicator (13)** is off.

6.4. Factory Reset

It is recommended to reset the device to its factory settings after each setup or use. If you do not reset the device, the next time you turn it on, it will continue operating in the last selected operation mode. After factory reset, when you turn on the device, it will enter into hotspot mode.

If the device is turned off, to reset the device, follow the steps below:

- 01) Set the **power switch (14)** to ON position to turn on the device.
- 02) Press and hold down the **reset button (07)** together with the **manual control button (01)** for 5 seconds. To access the **reset button (07)**, use a pin or a thin screwdriver.

If the device is switched on in manual control mode (see **6.6.1.1. Switching on the Device** on page 20), to reset the device:

Press and hold down the **reset button (07)** for 5 seconds. To access the **reset button (07)**, use a pin or a thin screwdriver.

6.5. Control Modes

The EventLITE Table RGBW can be controlled manually, via infrared (IR) remote control, and via Wi-Fi. The table below shows the different control options and the available features for each control mode.

| | Manual | IR Remote | Wi-Fi | |
|------------------------------|----------|-----------|---------------|------------------------|
| | | | Web interface | DMX via Art-Net (sACN) |
| Number of devices | 1 | > 1 | 1 | > 1 |
| Auto mode | Yes | Yes | Yes | No |
| Built-in programs | Yes | Yes | Yes | Yes |
| Static colors | Yes (15) | Yes (15) | Yes (15) | Yes (33) |
| Custom colors (Dimming mode) | No | Yes | Yes | Yes |
| Custom chases | No | No | No | Yes |
| Strobe | No | Yes | Yes | Yes |
| Speed | No | Yes | Yes | Yes |
| Configuration | No | No | Yes | No |

6.6. Manual Control

The device can be controlled via the **manual control button (01)**.

Note:

The **manual control button (01)** can be disabled via the web interface. If the **manual control button (01)** is disabled, the device cannot be controlled manually and the **manual control button (01)** does not function. See **6.8.2. Setup Devices** on page 27 for more information.

6.6.1. Functions of the Manual Control Button

The **manual control button (01)** has the following functions:

6.6.1.1. Switching on the Device

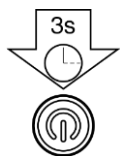

Press and hold down the **manual control button (01)** for 3 seconds to switch on the device. The **battery LED indicator (15)** lights up.

6.6.1.2. Switching off the Device

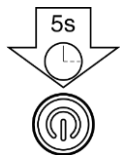

Press and hold down the **manual control button (01)** for 5 seconds to switch off the device. The **battery LED indicator (15)** turns off.

6.6.1.3. Battery Status Check

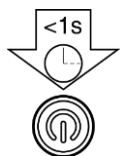

If the device is not running, press the **manual control button (01)** and release it within 1 second to see the battery status. See **4.5. Battery LED Indicator Statuses** on page 14 for more information.

6.6.1.4. Navigation

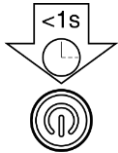

If the device is running, press the **manual control button (01)** and release it within 1 second to go to the options in the respective operation mode. See **6.6.2. Operation Modes** on page 21 for more information.

6.6.1.5. Switching between Operation Modes

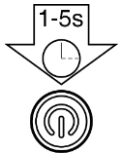

If the device is running, press and hold down the **manual control button (01)** for more than 1 second and release it within 5 seconds to switch to the next operation mode. See **6.6.2. Operation Modes** on page 21 for more information.

6.6.2. Operation Modes

When you control the device manually, the operation modes run in the following sequence:

1. Auto mode
2. Built-in programs
3. Static colors
4. Dimming mode
5. DMX mode

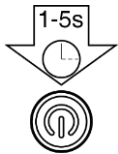

Press and hold down the **manual control button (01)** for more than 1 second and release it within 5 seconds to switch to the next operation mode.

Notes:

- When you turn off the device, the next time you turn it on, it will continue to operate in the previously selected operation mode. For example, if you play one of the built-in programs, the next time you turn on the device, it will start playing the last selected built-in program.
- In manual control mode you cannot control the speed of the built-in programs or add strobe effect. You can do this with the remote control or via the web interface.

6.6.2.1. Auto Mode

In this operation mode the device plays the built-in programs continuously. See **6.6.2.2. Built-in Programs** on page 22 for the sequence of the built-in programs.

6.6.2.2. Built-in Programs

In this operation mode the device plays the selected built-in program.

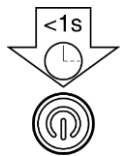

Press the **manual control button (01)** and release it within 1 second to go to the next built-in program.

There are 15 built-in programs available: 8 color jump programs and 7 color fade programs. The sequence of the built-in programs is as follows:

- R / G / B / W / Y / C / M / W – Jump
- Red / Magenta / White – Jump
- Green / Magenta – Jump
- R / W / R / B – Jump
- Blue / White Flash / Red / White Flash – Jump
- Magenta / White / Green / White – Jump
- Cyan / Amber – Jump
- Blue / White – Jump
- Rainbow – Fade
- R / G / C / B / M / W – Fade
- R / W / G / W / B / W – Fade
- R / W / G / W / B / W – Slow Fade
- Red / Green / Blue – Fade
- Green / Magenta – Fade
- Rainbow – Slow Fade

6.6.2.3. Static Colors

In this operation mode you can choose one of the static color presets.

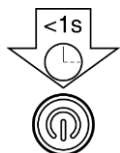

Press the **manual control button (01)** and release it within 1 second to go to the next static color preset.

There are 15 static color presets in the following sequence:

- | | | | | |
|----------|-----------|-----------|-----------------|----------------|
| 1. Red | 4. White | 7. Yellow | 10. Cyan | 13. Light blue |
| 2. Green | 5. Amber | 8. Purple | 11. Light red | 14. Warm white |
| 3. Blue | 6. Orange | 9. Pink | 12. Light green | 15. Cold white |

6.6.2.4. Dimming Mode

In this operation mode you can adjust the LEDs intensity separately for the red, green, blue and white colors. Use the remote control to increase or decrease the values. Follow steps 2–3 from **6.7.2.4. Dimming Mode** on page 25.

6.6.2.5. DMX Mode

In this operation mode you can control the device with a controller that supports DMX over Art-Net/s-ACN, or via a personal computer with Art-Net software. See **6.9. DMX Channels** on pages 33–35 for complete description of the DMX channels

6.7. Remote Control

The device can be controlled with an IR remote control. The remote control (product code: **44002**) is not included in the delivery. You can purchase the remote control with any Highlite International dealer.



DANGER
Do not ingest battery, chemical burn hazard

The remote control contains a coin cell battery. If the coin cell battery is swallowed, it can cause severe internal burns in just 2 hours and can lead to death.

You can control several devices at the same time with the remote control.

Make sure that you point the remote control to the **infrared port (12)** of the device or group of devices that you want to control, as shown in Fig. 09. If you point the remote control to the **infrared port (12)** of the device outside of the range of the sensor ($> 70^\circ$), the device will not respond to the remote control.



Fig. 09

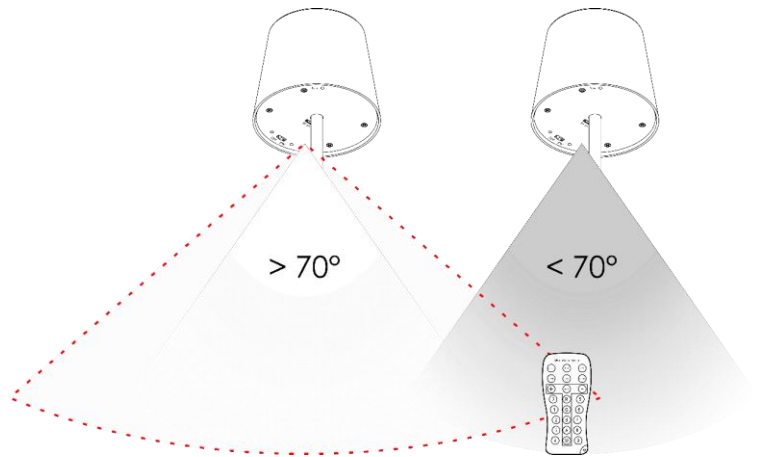

Fig. 10

6.7.1. Functions of the Remote Control Buttons

The remote control has the following functions:

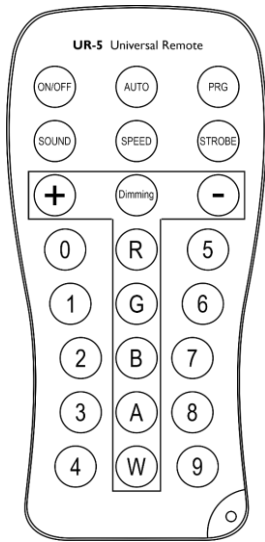

Fig. 11

| Button | Description | Function |
|---------|-------------|---|
| ON/OFF | On/Off | Turns the LEDs on/off |
| AUTO | Auto | Auto mode |
| PRG | Program | Built-in programs mode |
| SOUND | Sound | No function |
| SPEED | Speed | Speed adjustment of the built-in programs |
| STROBE | Strobe | Adds strobe effect |
| Dimming | Dimming | Dimming mode |
| + | Plus | Increases the value or selects the next program |
| - | Minus | Decreases the value or selects the previous program |

| Button | Description | Function |
|--------|-------------|---------------------------------|
| R | Red | Activates the red color |
| G | Green | Activates the green color |
| B | Blue | Activates the blue color |
| A | Amber | Activates the amber color |
| W | White | Activates the white color |
| 0 | Color 1 | Activates the cyan color |
| 1 | Color 2 | Activates the purple color |
| 2 | Color 3 | Activates the pink color |
| 3 | Color 4 | Activates the orange color |
| 4 | Color 5 | Activates the white color |
| 5 | Color 6 | Activates the light red color |
| 6 | Color 7 | Activates the light green color |
| 7 | Color 8 | Activates the light blue color |
| 8 | Color 9 | Activates the yellow color |
| 9 | Color 10 | Activates the warm white color |

6.7.2. Operation Modes

When you control the device with the remote control, the following operation modes are possible:

- Auto mode
- Built-in programs
- Static colors
- Dimming mode

6.7.2.1. Auto Mode

Press the **AUTO** button to activate the auto operation mode. The device plays the built-in programs continuously.

6.7.2.2. Built-in Programs

In this mode you can select one of the built-in programs.

- 01) Press the **PROGRAM** button to activate the built-in programs mode.
- 02) Press the **PLUS/MINUS** buttons to select one of the built-in programs. There are 15 built-in programs available: 8 color jump programs and 7 color fade programs, in this sequence:
 - R / G / B / W / Y / C / M / W – Jump
 - Red / Magenta / White – Jump
 - Green / Magenta – Jump
 - R / W / R / B – Jump
 - Blue / White Flash / Red / White Flash – Jump
 - Magenta / White / Green / White – Jump
 - Cyan / Amber – Jump
 - Blue / White – Jump
 - Rainbow – Fade
 - R / G / C / B / M / W – Fade
 - R / W / G / W / B / W – Fade
 - R / W / G / W / B / W – Slow Fade
 - Red / Green / Blue – Fade
 - Green / Magenta – Fade
 - Rainbow – Slow Fade

To change the speed of the built-in program:

- 01) Press the **SPEED** button.
- 02) Press the **PLUS/MINUS** buttons to increase or decrease the speed at which the program is played. The adjustment range is 0–10, from slow to fast.

To add strobe effect:

- 01) Press the **STROBE** button.
- 02) Press the **PLUS/MINUS** buttons to increase or decrease the strobe frequency. The adjustment range is 0–20 Hz.

6.7.2.3. Static Colors

Press one of the **R, G, B, W, A** or **0–9 buttons** to activate the desired color.

To add strobe effect:

- 01) Press the **STROBE** button.
- 02) Press the **PLUS/MINUS** buttons to increase or decrease the strobe frequency. The adjustment range is 0–20 Hz.

6.7.2.4. Dimming Mode

In this operation mode you can adjust the LEDs intensity separately for the red, green, blue and white colors.

- 01) Press the **DIMMER** button to activate the dimming mode.
- 02) Press the **RED/GREEN/BLUE/WHITE** buttons to select the color.
- 03) Press the **PLUS/MINUS** buttons to increase or decrease the intensity. The adjustment range is 0–10, from low to high intensity.

6.8. Control via the Web Interface

You can control the device and configure its settings via the web interface. You can access the web interface from the Internet browser on a personal computer.

To access the web interface, follow the steps below:

- 01) Connect the device to a personal computer. See **5.2.1. Wi-Fi Connection of a Single Device** on page 15 for more information.
- 02) Open the Internet browser on the personal computer.
- 03) Enter the IP address of the device into the address bar of the browser: 192.168.4.1.
- 04) Press Enter on the keyboard of the personal computer to open the web interface in the browser.

Note:

If the device is connected via the router to a personal computer, the IP address is assigned by the network.

The web interface offers the following configuration sections:

- Wi-Fi Setup
- Setup Devices
- Art-Net Configuration
- sACN Configuration

There are two buttons at the bottom right corner in each section of the web interface: **Load** and **Save**.

- Click the **Load** button to load the current active settings in the respective section.
- Click the **Save** button to save the changes you made in the respective section.

6.8.1. Wi-Fi Setup

In this section you can connect the device to the router:

- 01) Enter the SSID name of the router in the **SSID** field.
- 02) Enter the password of the router in the **Password** field.
- 03) Click **Save** to save the changes and complete the Wi-Fi setup. A confirmation dialog box will pop up to confirm that the changes are saved.
- 04) Click **Ok** to close the pop-up confirmation box.

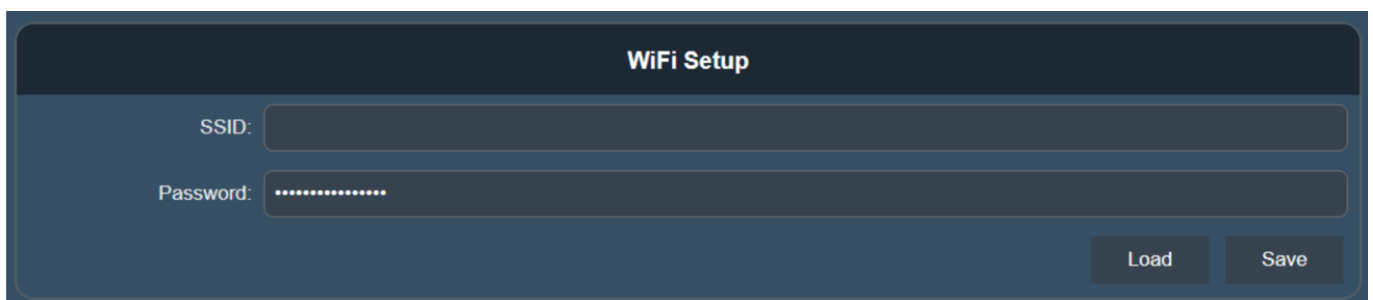

6.8.2. Setup Devices

In this section you can select the control mode of the device and adjust general settings of the device.

- 01) Select the control mode of the device from the dropdown menu in the **Control Mode** field. The following options are available:
- **Auto:** In this mode you can play the built-in programs continuously, adjust the speed and add strobe effect. See **6.8.2.1. Auto Mode** on page 28 for more information
 - **Program:** In this mode you can play one of the 15 built-in programs: 8 color jump programs and 7 color fade programs, adjust the speed and add strobe effect. See **6.8.2.2. Built-in Programs** on page 29 for more information
 - **Static:** In this mode you can choose one of the static color presets. See **6.8.2.3. Static Colors** on page 30 for more information
 - **Dimmer:** In this mode you can adjust the LEDs intensity separately for the red, green, blue and white colors. See **6.8.2.4. Dimming Mode** on page 30 for more information
 - **DMX:** In this mode you can configure the DMX settings of the device and select one of the 6 DMX personalities. See **6.8.2.5. DMX Mode** on page 31 for more information
- 02) Change the name of the device in the **Fixture Name** field, if necessary. The default name of the device is 'EventLITE Table-C'.
- 03) Select the behavior of the **manual control button (01)** in the **Touch Button** field. There are 3 options available:
- **Normal:** You can control the device from the **manual control button (01)**
 - **Lock when Wi-Fi connected:** The **manual control button (01)** does not function when the device is connected via Wi-Fi
 - **Lock when DMX present:** The **manual control button (01)** does not function when the device receives DMX signal
- 04) Select the behavior of the **Wi-Fi LED indicator (13)** and the **battery LED indicator (15)** in the **LED Mode** field. There are 2 options available:
- **Normal:** The **Wi-Fi LED indicator (13)** and the **battery LED indicator (15)** are always on
 - **LED off after 30 s when idle:** The **Wi-Fi LED indicator (13)** and the **battery LED indicator (15)** turn off automatically after 30 seconds of inactivity

The screenshot shows a configuration interface with three settings:

- Fixture Name:** EventLITE Table-C
- Touch Button:** Normal
- LED Mode:** Normal

6.8.2.1. Auto Mode

- 01) Select Auto from the dropdown menu in the **Control Mode** field.
- 02) Slide the **Speed** slider to change the speed of the auto program.
- 03) Slide the **Strobe** slider to add strobe effect.
- 04) Click **Save** to save the changes. A confirmation dialog box will pop up to confirm that the changes are saved. The device will play continuously the built-in programs with the selected speed and strobe frequency.
- 05) Click **Ok** to close the pop-up confirmation box.

The screenshot shows a 'Setup Devices' window with the following fields and controls:

- Control Mode:** A dropdown menu set to 'Auto'.
- Speed:** A horizontal slider control.
- Strobe:** A horizontal slider control.
- Fixture Name:** A text input field containing 'EventLITE Table-C'.
- Touch Button:** A dropdown menu set to 'Normal'.
- LED Mode:** A dropdown menu set to 'Normal'.

At the bottom right of the window, there are two buttons: 'Load' and 'Save'.

6.8.2.2. Built-in Programs

- 01) Select Program from the dropdown menu in the **Control Mode** field.
- 02) Select the built-in program from the dropdown menu in the **Program** field. There are 15 built-in programs available: 8 color jump programs and 7 color fade programs.
 - R / G / B / W / Y / C / M / W – Jump
 - Red / Magenta / White – Jump
 - Green / Magenta – Jump
 - R / W / R / B – Jump
 - Blue / White Flash / Red / White Flash – Jump
 - Magenta / White / Green / White – Jump
 - Cyan / Amber – Jump
 - Blue / White – Jump
 - Rainbow – Fade
 - R / G / C / B / M / W – Fade
 - R / W / G / W / B / W – Fade
 - R / W / G / W / B / W – Slow Fade
 - Red / Green / Blue – Fade
 - Green / Magenta – Fade
 - Rainbow – Slow Fade
- 03) Slide the **Speed** slider to change the speed of the built-in program.
- 04) Slide the **Strobe** slider to add strobe effect.
- 05) Click **Save** to save the changes. A confirmation dialog box will pop up to confirm that the changes are saved. The device will play the built-in program with the selected speed and strobe frequency.
- 06) Click **Ok** to close the pop-up confirmation box.

Setup Devices

Control Mode: Program ◇

Program: R / G / B / W / Y / C / M / W - Jump ◇

Speed:

Strobe:

Fixture Name: EventLITE Table-C

Touch Button: Normal ◇

LED Mode: Normal ◇

Load
Save

6.8.2.3. Static Colors

- 01) Select Static from the dropdown menu in the **Control Mode** field.
- 02) Select the color from the dropdown menu in the **Color** field. There are 15 static color presets available:

| | | | | |
|----------|-----------|-----------|-----------------|----------------|
| 1. Red | 4. White | 7. Yellow | 10. Cyan | 13. Light blue |
| 2. Green | 5. Amber | 8. Purple | 11. Light red | 14. Warm white |
| 3. Blue | 6. Orange | 9. Pink | 12. Light green | 15. Cold white |
- 03) Slide the **Strobe** slider to add strobe effect.
- 04) Click **Save** to save the changes. A confirmation dialog box will pop up to confirm that the changes are saved.
- 05) Click **Ok** to close the pop-up confirmation box.

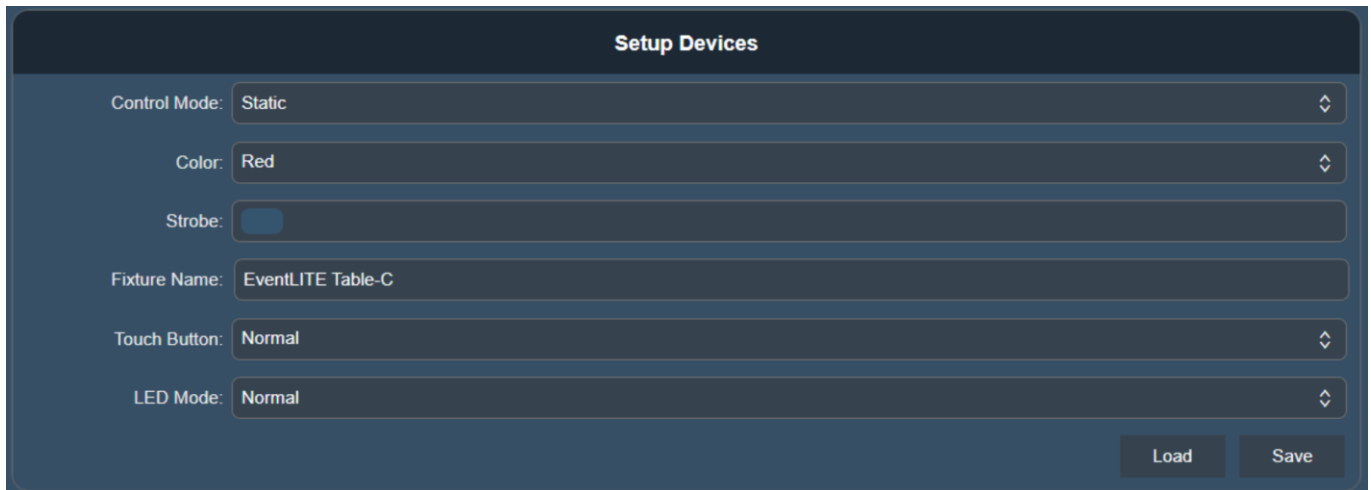

6.8.2.4. Dimming Mode

- 01) Select Dimmer from the dropdown menu in the **Control Mode** field.
- 02) Slide the **Red**, **Green**, **Blue** and **White** sliders to increase or decrease the intensity of each color separately.
- 03) Click **Save** to save the changes. A confirmation dialog box will pop up to confirm that the changes are saved.
- 04) Click **Ok** to close the pop-up confirmation box.



6.8.2.5. DMX Mode

- 01) Select DMX from the dropdown menu in the **Control Mode** field.
- 02) Select the control protocol in the **DMX Input** field. There are 2 options available:
 - Art-Net: See **6.8.3. Art-Net Configuration** on page 32 for more information
 - sACN: See **6.8.4. sACN Configuration** on page 32 for more information
- 03) Select the send style from the dropdown menu in the **Send Style** field. There are 2 options available:
 - Changes Only: The device outputs only when it receives a signal
 - Hold Last Signal: The device continues outputting the last received signal until it receives a new signal
- 04) Select the DMX personality from the dropdown menu in the **DMX Mode** field. There are 6 personalities available. See **6.9. DMX Channels** on pages 33–35 for complete description of the DMX channels.
 - 1-Ch (Color)
 - 2-Ch (Program / Speed)
 - 4-Ch (Red / Green / Blue / White)
 - 5-Ch (Dimmer / Strobe / Color / Program / Speed)
 - 6-Ch (Dimmer / Strobe / Red / Green / Blue / White)
 - 9-Ch (Dimmer / Strobe / Color / Program / Speed / Red / Green / Blue / White)
- 05) Enter the DMX starting address of the device in the **DMX Address** field. The entry range is 1–512. See **5.3.1. DMX Addressing** on page 17 for more information.
- 06) Click **Save** to save the changes. A confirmation dialog box will pop up to confirm that the changes are saved.
- 07) Click **Ok** to close the pop-up confirmation box.

Setup Devices

| | | |
|---------------|-----------------------------------|---|
| Control Mode: | DMX | ⌵ |
| DMX Input: | Art-Net | ⌵ |
| Send Style: | Changes Only | ⌵ |
| DMX Mode: | 4-Ch (Red / Green / Blue / White) | ⌵ |
| DMX Address: | 1 | |
| Fixture Name: | EventLITE Table-C | |
| Touch Button: | Normal | ⌵ |
| LED Mode: | Normal | ⌵ |

Load
Save

6.8.3. Art-Net Configuration

This section on the web interface is visible only when you select Art-Net in the **DMX Input** field. See **6.8.2.5. DMX Mode** on page 31 for more information.

- 01) Enter the universe value in the **Universe** field. The entry range is 0–127.
- 02) Click **Save** to save the changes and complete the Art-Net configuration. A confirmation dialog box will pop up to confirm that the changes are saved.
- 03) Click **Ok** to close the pop-up confirmation box.

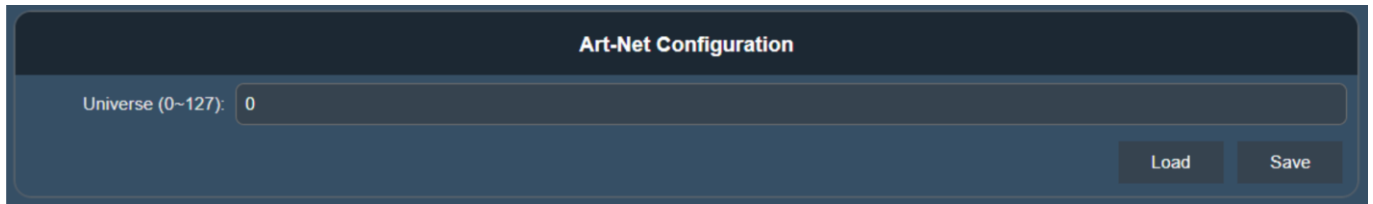

Note:

See **5.3.2. Universe Numbering** on page 18 for more information.

6.8.4. sACN Configuration

This section on the web interface is visible only when you select sACN in the **DMX Input** field. See **6.8.2.5. DMX Mode** on page 31 for more information.

- 01) Enter the universe value in the **Universe** field. The entry range is 1–65535.
- 02) Click **Save** to save the changes and complete the sACN configuration. A confirmation dialog box will pop up to confirm that the changes are saved.
- 03) Click **Ok** to close the pop-up confirmation box.

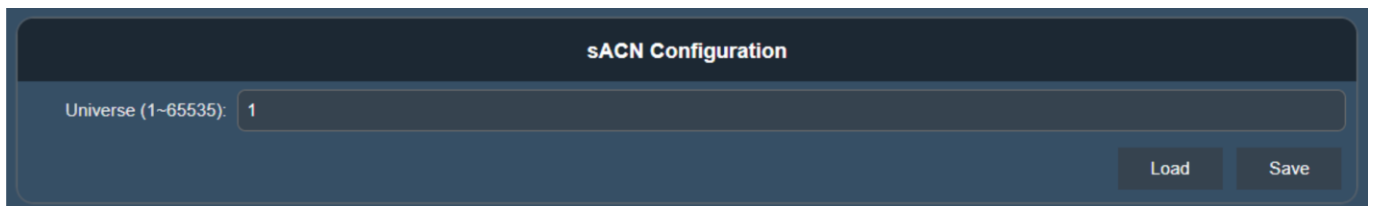

Note:

See **5.3.2. Universe Numbering** on page 18 for more information.

6.9. DMX Channels

6.9.1. DMX Channels Overview

| Function | 1 CH | 2 CH | 4 CH | 5 CH | 6 CH | 9 CH |
|-------------------|------|------|------|------|------|------|
| Master Dimmer | | | | 1 | 1 | 1 |
| Linear Strobe | | | | 2 | 2 | 2 |
| Color Presets | 1 | | | 3 | | 3 |
| Built-in Programs | | 1 | | 4 | | 4 |
| Speed | | 2 | | 5 | | 5 |
| Red | | | 1 | | 3 | 6 |
| Green | | | 2 | | 4 | 7 |
| Blue | | | 3 | | 5 | 8 |
| White | | | 4 | | 6 | 9 |

6.9.2. 1 Channel, 2 Channels

| 1 CH | 2 CH | Function | Value | Setting |
|---------|-------------------------------------|-------------------|---------|--|
| 1 | | Color Presets | 000–007 | No function |
| | | | 008–013 | Color 1 R 255; G 000; B 000; W 000 |
| | | | 014–020 | Color 2 R 255; G 000; B 000; W 100 |
| | | | 021–027 | Color 3 R 255; G 000; B 000; W 200 |
| | | | 028–034 | Color 4 R 255; G 050; B 000; W 000 |
| | | | 035–041 | Color 5 R 255; G 150; B 000; W 000 |
| | | | 042–048 | Color 6 R 255; G 255; B 000; W 000 |
| | | | 049–055 | Color 7 R 255; G 255; B 000; W 075 |
| | | | 056–062 | Color 8 R 000; G 255; B 000; W 255 |
| | | | 063–069 | Color 9 R 000; G 255; B 000; W 150 |
| | | | 070–076 | Color 10 R 000; G 255; B 000; W 050 |
| | | | 077–083 | Color 11 R 000; G 255; B 000; W 000 |
| | | | 084–090 | Color 12 R 000; G 255; B 050; W 000 |
| | | | 091–097 | Color 13 R 000; G 255; B 150; W 000 |
| | | | 098–104 | Color 14 R 000; G 255; B 255; W 000 |
| | | | 105–111 | Color 15 R 000; G 255; B 255; W 075 |
| | | | 112–118 | Color 16 R 000; G 255; B 255; W 150 |
| | | | 119–125 | Color 17 R 000; G 100; B 255; W 255 |
| | | | 126–132 | Color 18 R 000; G 000; B 255; W 100 |
| | | | 133–139 | Color 19 R 000; G 000; B 255; W 050 |
| | | | 140–146 | Color 20 R 000; G 000; B 255; W 000 |
| | | | 147–153 | Color 21 R 075; G 000; B 255; W 000 |
| | | | 154–160 | Color 22 R 160; G 000; B 255; W 000 |
| | | | 161–167 | Color 23 R 255; G 000; B 255; W 000 |
| | | | 168–174 | Color 24 R 255; G 000; B 175; W 000 |
| | | | 175–181 | Color 25 R 255; G 000; B 100; W 000 |
| | | | 182–188 | Color 26 R 255; G 000; B 100; W 050 |
| | | | 189–195 | Color 27 R 255; G 000; B 025; W 050 |
| | | | 196–202 | Color 28 R 255; G 000; B 025; W 025 |
| | | | 203–209 | Color 29 R 255; G 000; B 025; W 000 |
| | | | 210–216 | Color 30 R 000; G 000; B 000; W 255 |
| | | | 217–223 | Color 31 R 075; G 075; B 000; W 255 |
| | | | 224–230 | Color 32 R 000; G 000; B 100; W 255 |
| 231–255 | Color 33 R 255; G 255; B 255; W 255 | | | |
| 1 | | Built-in Programs | 000–015 | No function |
| | | | 016–031 | Color jump 1 R / G / B / W / Y / C / M / W |
| | | | 032–047 | Color jump 2 Red / Magenta / White |
| | | | 048–063 | Color jump 3 Green / Magenta |

| 1 CH | 2 CH | Function | Value | Setting |
|------|----------|--------------|---------|---|
| | | | 064-079 | Color jump 4 R / W / R / B |
| | | | 080-095 | Color jump 5 Blue / White Flash / Red / White Flash |
| | | | 096-111 | Color jump 6 Magenta / White / Green / White |
| | | | 112-127 | Color jump 7 Cyan / Amber |
| | | | 128-143 | Color jump 8 Blue / White |
| | | | 144-159 | Color fade 1 Rainbow |
| | | | 160-175 | Color fade 2 R / G / C / B / M / W |
| | | | 176-191 | Color fade 3 R / W / G / W / B / W |
| | | | 192-207 | Color fade 4 R / W / G / W / B / W (slow) |
| | | | 208-223 | Color fade 5 Red / Green / Blue |
| | | | 224-239 | Color fade 6 Green / Magenta |
| | | | 240-255 | Color fade 7 Rainbow (slow) |
| | 2 | Speed | 000-255 | From slow to fast |

6.9.3. 4 Channels, 5 Channels, 6 Channels, 9 channels

| 4 CH | 5 CH | 6 CH | 9 CH | Function | Value | Setting |
|------|----------|----------|----------|----------------------|---------|--------------------------------------|
| | 1 | 1 | 1 | Master Dimmer | 000-255 | From low to high intensity (0-100 %) |
| | 2 | 2 | 2 | Linear Strobe | 000-010 | No function |
| | | | | | 011-255 | From low to high frequency |
| | | | | | 000-007 | No function |
| | | | | | 008-013 | Color 1 R 255; G 000; B 000; W 000 |
| | | | | | 014-020 | Color 2 R 255; G 000; B 000; W 100 |
| | | | | | 021-027 | Color 3 R 255; G 000; B 000; W 200 |
| | | | | | 028-034 | Color 4 R 255; G 050; B 000; W 000 |
| | | | | | 035-041 | Color 5 R 255; G 150; B 000; W 000 |
| | | | | | 042-048 | Color 6 R 255; G 255; B 000; W 000 |
| | | | | | 049-055 | Color 7 R 255; G 255; B 000; W 075 |
| | | | | | 056-062 | Color 8 R 000; G 255; B 000; W 255 |
| | | | | | 063-069 | Color 9 R 000; G 255; B 000; W 150 |
| | | | | | 070-076 | Color 10 R 000; G 255; B 000; W 050 |
| | | | | | 077-083 | Color 11 R 000; G 255; B 000; W 000 |
| | | | | | 084-090 | Color 12 R 000; G 255; B 050; W 000 |
| | | | | | 091-097 | Color 13 R 000; G 255; B 150; W 000 |
| | | | | | 098-104 | Color 14 R 000; G 255; B 255; W 000 |
| | 3 | | 3 | Color Presets | 105-111 | Color 15 R 000; G 255; B 255; W 075 |
| | | | | | 112-118 | Color 16 R 000; G 255; B 255; W 150 |
| | | | | | 119-125 | Color 17 R 000; G 100; B 255; W 255 |
| | | | | | 126-132 | Color 18 R 000; G 000; B 255; W 100 |
| | | | | | 133-139 | Color 19 R 000; G 000; B 255; W 050 |
| | | | | | 140-146 | Color 20 R 000; G 000; B 255; W 000 |
| | | | | | 147-153 | Color 21 R 075; G 000; B 255; W 000 |
| | | | | | 154-160 | Color 22 R 160; G 000; B 255; W 000 |
| | | | | | 161-167 | Color 23 R 255; G 000; B 255; W 000 |
| | | | | | 168-174 | Color 24 R 255; G 000; B 175; W 000 |
| | | | | | 175-181 | Color 25 R 255; G 000; B 100; W 000 |
| | | | | | 182-188 | Color 26 R 255; G 000; B 100; W 050 |
| | | | | | 189-195 | Color 27 R 255; G 000; B 025; W 050 |
| | | | | | 196-202 | Color 28 R 255; G 000; B 025; W 025 |
| | | | | | 203-209 | Color 29 R 255; G 000; B 025; W 000 |
| | | | | | 210-216 | Color 30 R 000; G 000; B 000; W 255 |
| | | | | | 217-223 | Color 31 R 075; G 075; B 000; W 255 |
| | | | | | 224-230 | Color 32 R 000; G 000; B 100; W 255 |

| 4 CH | 5 CH | 6 CH | 9 CH | Function | Value | Setting |
|----------|----------|----------|----------|--------------------------|---------|---|
| | | | | | 231–255 | Color 33 R 255; G 255; B 255; W 255 |
| | | | | | 000–015 | No function |
| | | | | | 016–031 | Color jump 1 R / G / B / W / Y / C / M / W |
| | | | | | 032–047 | Color jump 2 Red / Magenta / White |
| | | | | | 048–063 | Color jump 3 Green / Magenta |
| | | | | | 064–079 | Color jump 4 R / W / R / B |
| | | | | | 080–095 | Color jump 5 Blue / White Flash / Red / White Flash |
| | | | | | 096–111 | Color jump 6 Magenta / White / Green / White |
| | | | | | 112–127 | Color jump 7 Cyan / Amber |
| | | | | | 128–143 | Color jump 8 Blue / White |
| | | | | | 144–159 | Color fade 1 Rainbow |
| | | | | | 160–175 | Color fade 2 R / G / C / B / M / W |
| | | | | | 176–191 | Color fade 3 R / W / G / W / B / W |
| | | | | | 192–207 | Color fade 4 R / W / G / W / B / W (slow) |
| | | | | | 208–223 | Color fade 5 Red / Green / Blue |
| | | | | | 224–239 | Color fade 6 Green / Magenta |
| | | | | | 240–255 | Color fade 7 Rainbow (slow) |
| | 4 | | 4 | Built-in Programs | | |
| | | | | | 000–255 | From slow to fast |
| 1 | | 3 | 6 | Red | 000–255 | From low to high intensity (0–100 %) |
| 2 | | 4 | 7 | Green | 000–255 | From low to high intensity (0–100 %) |
| 3 | | 5 | 8 | Blue | 000–255 | From low to high intensity (0–100 %) |
| 4 | | 6 | 9 | White | 000–255 | From low to high intensity (0–100 %) |

Note: Make sure that the Master Dimmer channel is open in 5-CH, 6-CH and 9-CH mode in order to see the light output.

7. Troubleshooting

This troubleshooting guide contains solutions to problems which can be carried out by an ordinary person. The device does not contain user-serviceable parts.

Unauthorized modifications to the device will render the warranty void. Such modifications may result in injuries and material damage.

Refer servicing to instructed or skilled persons. Contact your Highlite International dealer in case the solution is not described in the table.

| Problem | Probable cause(s) | Solution |
|--|---|--|
| The device does not turn on | The battery is depleted | <ul style="list-style-type: none"> Recharge the battery. See 4.4. Charging the Battery on page 14 |
| The device responds erratically | The device is operating in a previously selected mode | <ul style="list-style-type: none"> Reset the device to the factory settings. See 6.4. Factory Reset on page 19 |
| The device does not appear on the list with networks | The device is not in hotspot mode | <ul style="list-style-type: none"> Reset the device to the factory settings. See 6.4. Factory Reset on page 19 |
| The device does not respond to manual control | The manual control button is disabled | <ul style="list-style-type: none"> Enable the operation of the manual control button via the web interface. See 6.8.2. Setup Devices on page 27 |
| | The battery is depleted | <ul style="list-style-type: none"> Recharge the battery. See 4.4. Charging the Battery on page 14 |
| The device does not respond to the remote control | The remote control is outside of the range of the sensor of the infrared port | <ul style="list-style-type: none"> Walk closer to the device or change the angle at which you point the remote control to the device. See 6.7. Remote Control on page 23 |
| | The battery of the remote control is depleted | <ul style="list-style-type: none"> Change the battery of the remote control |
| The LED indicators do not function | The LED indicators are turned off | <ul style="list-style-type: none"> Change the settings for the LED indicators via the web interface. See 6.8.2. Setup Devices on page 27 |

8. Maintenance

8.1. Preventive Maintenance



Attention

Before each use, examine the device visually for any defects.

8.1.1. Basic Cleaning Instructions

To clean the device, follow the steps below:

- 01) Switch off the device.
- 02) Clean the device with a damp cloth.



Attention

- Do not immerse the device in liquid.
- Do not use alcohol or solvents.

8.2. Corrective Maintenance

The device does not contain user-serviceable parts. Do not open the device and do not modify the device.

Refer repairs and servicing to instructed or skilled persons. Contact your Highlite International dealer for more information.

9. Transportation and Storage

9.1. Instructions for Transportation

This device contains a rechargeable (secondary) lithium-ion battery. Lithium-ion batteries contained in equipment fall under the category of dangerous goods for transportation.

Make sure that you are in compliance with all applicable transportation regulations when you transport this device. See **3.3. Product Specifications** on page 10 for the specifications of the battery.

Use the original packaging to transport the device or other suitable packaging that complies with the regulations for transportation of secondary lithium-ion batteries.

9.2. Storage

This device contains a rechargeable (secondary) lithium-ion battery. The battery is not replaceable. The battery may explode or cause burns if it is crushed, disassembled or exposed to fire or high temperatures.

- Store the device in a dry place, at temperatures between 5 °C and 20 °C. Lithium-ion batteries self-discharge during storage. Temperatures above 20 °C speed up the self-discharging process.
- Do not store the device with depleted battery. Make sure that the battery is charged to at least 50 % before storing the device. See **4.4. Charging the Battery** on page 14.
- If the device is stored for an extended period, check the battery's charge status regularly. See **6.6.1.3. Battery Status Check** on page 20.
- Clean the device before storing. Follow the cleaning instructions in chapter **8.1.1. Basic Cleaning Instructions** on page 37.
- Store the device in the original packaging, if possible.

10. Disposal

This device contains a lithium-ion battery. Do not dispose of with the household waste.

Correct disposal of this product

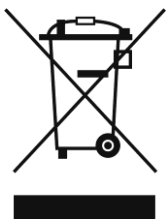

Waste Electrical and Electronic Equipment

This symbol on the product, its packaging or documents indicates that the product shall not be treated as household waste. Dispose of this product by handing it to the respective collection point for recycling of electrical and electronic equipment. This is to avoid environmental damage or personal injury due to uncontrolled waste disposal. For more detailed information about recycling of this product contact the local authorities or the authorized dealer.

11. Approval



Hereby, Highlite International declares that the device EventLITE Table RGBW, product codes: 44030, 44031, and 44032, is in compliance with Directive 2014/53/EU (RED – Radio Equipment Directive).

The full text of the EU declaration of conformity is available at the respective product page on the website of Highlite International (www.highlite.com).



©2022 Showtec