

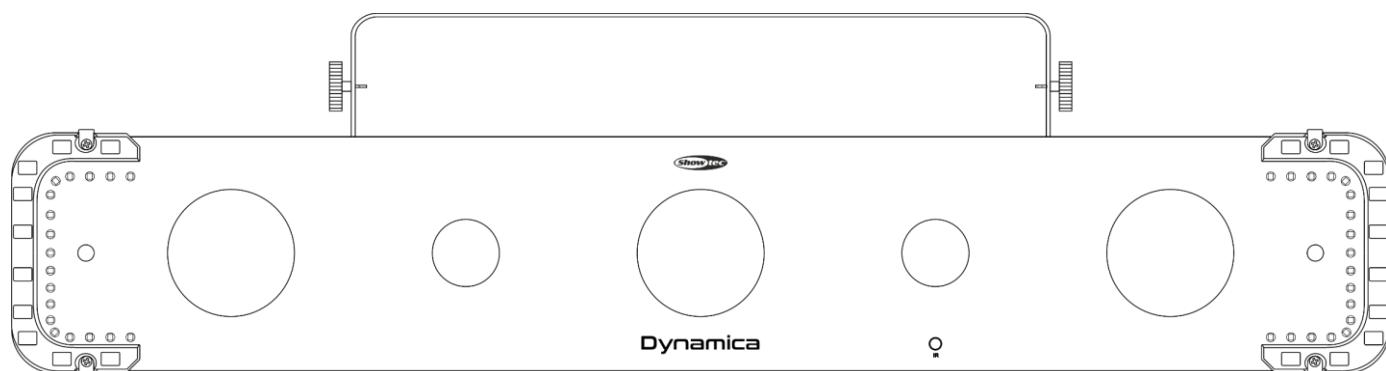

MANUAL



ENGLISH

Dynamica

V1

Ordercode: 43162

Table of contents

Warning	2
Safety Instructions	2
Operating Determinations	5
Laser safety for a Class 2M Laser Product	5
Rigging	7
Connection with the mains	8
Return Procedure	8
Claims	8
Description of the device	9
Optional accessories	9
Frontside	10
Backside	10
Installation	11
Set Up and Operation	11
Control Modes	12
One Dynamica (Auto Programs)	12
One Dynamica (Sound-controlled)	12
Multiple Dynamicas (Master/Slave control)	13
Multiple Dynamicas (DMX Control)	13
Fixture Linking	14
Data Cabling	14
Control Panel	15
Control Mode	15
DMX Addressing	15
Menu Overview	16
Main Menu Options	16
1. Auto Run Programs	16
2. Sound-controlled Mode	17
3. DMX Address / DMX Channels	17
4. Slave mode	17
5. System Settings	17
Remote Control	18
DMX Channels	19
2 channels	19
5 channels	19
8 channels	21
10 channels	23
Maintenance	25
Replacing the Fuse	25
Troubleshooting	25
No Light	25
No Response to DMX	26
Product Specifications	28
Dimensions	29
Notes	30

Warning



**For your own safety, please read this user manual carefully
before your initial start-up!**



Unpacking Instructions

Immediately upon receiving this product, carefully unpack the carton and check the contents to ensure that all parts are present, and have been received in good condition. Notify the dealer immediately and retain packing material for inspection if any parts appear damaged from shipping or the carton itself shows signs of mishandling. Save the carton and all packing materials. In the event that a fixture must be returned to the factory, it is important that the fixture be returned in the original factory box and packing.

Your shipment includes:

- Showtec Dynamica incl. mounting bracket
- IEC Power cable (1,5 m)
- 2 keys for the interlock
- Remote control plug
- IR Remote control
- User manual

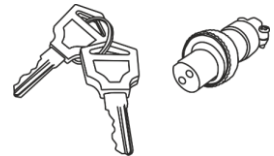
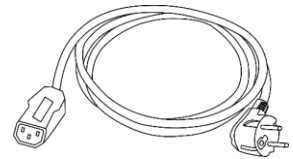
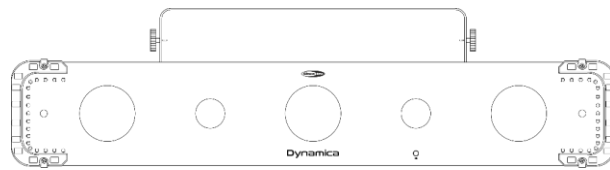

LED Expected Lifespan

LEDs gradually decline in brightness over time. HEAT is the dominant factor that leads to the acceleration of this decline. Packaged in clusters, LEDs exhibit higher operating temperatures than in ideal or singular optimum conditions. For this reason, when all color LEDs are used at their fullest intensity, life of the LEDs is significantly reduced. If improving the lifespan is of higher priority, place care in providing for lower operational temperatures. This may include climatic-environmental and the reduction of overall projection intensity.



CAUTION!
Keep this device away from rain and moisture!
Unplug mains lead before opening the housing!



Safety Instructions

Every person involved with the installation, operation and maintenance of this device has to:

- be qualified
- follow the instructions of this manual



**CAUTION! Be careful with your operations.
With a dangerous voltage you can suffer
a dangerous electric shock when touching the wires!**



Before the initial start-up, please make sure that there is no damage caused by transportation. Should there be any, consult your dealer and do not use the device.

To maintain perfect condition and to ensure a safe operation, it is absolutely necessary for the user to follow the safety instructions and warning notes contained in this manual.

Please consider that damages caused by manual modifications to the device are not subject to warranty.

This device contains no user-serviceable parts. Refer servicing to qualified technicians only.

IMPORTANT:

The manufacturer will not accept liability for any resulting damages caused by the non-observance of this manual or any unauthorized modification to the device.

- Never let the power cord come into contact with other cables! Handle the power cord and all connections with the mains with particular caution!
- Never modify, bend, mechanically strain, put pressure on, pull or heat up the power cord.
- Never strain the cable insert or the female part in the device. There must always be sufficient cable going to the device. Otherwise, the cable will be damaged, which can cause serious damage.
- Never remove warning or informative labels from the unit.
- Never use anything to cover the ground contact.
- Never lift the fixture holding it by the projector-head, as the mechanics may be damaged. Always hold the fixture by the transport handles.
- Never place any material over the lens or LEDs.
- Never look directly into the light source.
- Never leave any cables lying around.
- Never use the device during thunderstorms, unplug the device immediately.
- Never leave various parts of the packaging (plastic bags, polystyrene foam, nails, etc.) within children's reach, as they are potential sources of danger.
- Never aim the laser beam at people or animals!
- Never point a laser at aircraft, this is a federal offense.
- Never point unterminated laser beams into the sky.
- Never open the laser housing. The high laser power levels inside of the protective housing can start fires, burn skin and will cause instant eye injury.
- Do not insert objects into air vents.
- Do not open the device and do not modify the device.
- Do not connect this device to a dimmerpack.
- Do not point lasers at highly reflective surfaces such as windows, mirrors and shiny metal. Even laser reflections can be hazardous.
- Do not expose the output optic (aperture) to cleaning chemicals.
- Do not use laser if the laser appears to be emitting only one or two beams.
- Do not use laser if housing is damaged or open, or if optics appear damaged in any way.
- Do not operate laser without first reading and understanding all safety and technical data in this manual. Never look into the laser aperture or laser beams.
- Do not switch the device on and off in short intervals, as this will reduce the device's life.
- Do not touch the device's housing bare-handed during its operation (housing becomes very hot). Allow the fixture to cool for at least 5 minutes before handling.
- Do not shake the device. Avoid brute force when installing or operating the device.

- After set up and prior to public use, test laser to ensure proper function. Do not use the laser if any defect is detected. Do not use, if the laser emits only one or two laser beams rather than dozens/hundreds, as this could indicate damage to the diffraction grating optic, and could allow emission of higher laser levels.
- Only use the device indoors, avoid contact with water or other liquids.
- Only operate the fixture after having checked if the housing is firmly closed and all screws are tightly fastened.
- Only operate the device after having familiarized with its functions.
- Avoid flames and do not put close to flammable liquids or gases.
- Always check the regulations when using a class 2M laser product.
- Always check and position the laser before anybody enters the room, when the laser is facing an area with people.
- Always keep the case closed while operating.
- Always allow a free air space of at least 50 cm around the unit for ventilation.
- Always disconnect power from the mains, when device is not used or before cleaning! Only handle the power cord holding it by the plug. Never pull out the plug by tugging the power cord.
- Make sure that the device is not exposed to extreme heat, moisture or dust.
- Make sure that the available voltage is not higher than stated on the rear panel.
- Make sure that the power cord is never crimped or damaged. Check the device and the power cord from time to time.
- Make sure that the core diameter of extension cords and power cords is sufficient for the required power consumption of the device.
- If the external cable is damaged, it has to be replaced by a qualified technician.
- If the lens or LEDs are obviously damaged, it has to be replaced. So that its functions are not impaired, due to cracks or deep scratches.
- If device was dropped or struck, disconnect mains power supply immediately. Have a qualified engineer inspect for safety before operating.
- If the device has been exposed to drastic temperature fluctuation (e.g. after transportation), do not switch it on immediately. The arising condensation water might damage your device. Leave the device switched off until it has reached room temperature.
- If your Showtec device fails to work properly, discontinue the use immediately. Pack the unit securely (preferably in the original packing material), and return it to your Showtec dealer for service.
- For adult use only. The fixture must be installed beyond the reach of children. Never leave the unit running unattended.
- Never attempt to bypass the thermostatic switch or fuses.
- For replacement use fuses of same type and rating only.
- The operation of a class 2M laser show laser is only allowed if the show is controlled by a skilled and well-trained operator familiar with the data included in this manual.
- The user is responsible for correct positioning and operating of the Dynamica. The manufacturer will not accept liability for damages caused by the misuse or incorrect installation of this device.
- This device falls under protection class I. Therefore it is essential to connect the yellow/green conductor to earth.
- The laser will only work between 10-35°C.
- After 3 hours working, you must shut off the laser and let the laser diode cool off for 30 minutes, otherwise the laser could be damaged and the warranty becomes void.
- Repairs, servicing and electric connection must be carried out by a qualified technician.
- WARRANTY: Till one year after date of purchase.





CAUTION! Eyedamages!!!
Avoid looking directly into the lightsource!!!
(meant especially for epileptics)!!!





CAUTION! Eyedamages!!!
Never look directly into the lightsource!!!
Never project a single laser point!!!



Operating Determinations

- This device is not designed for permanent operation. Consistent operation breaks will ensure that the device will serve you for a long time without defects.
- The minimum distance between light output and the illuminated surface must be bigger than 1 meter.
- The maximum ambient temperature $t_a = 40^\circ\text{C}$ must never be exceeded.
- The relative humidity must not exceed 50 % with an ambient temperature of 40°C .
- If this device is operated in any other way than the one described in this manual, the product may suffer damages and the warranty becomes void.
- Any other operation may lead to dangers like short-circuit, burns, electric shock, crash, etc.

You endanger your own safety and the safety of others!

Laser safety for a Class 2M Laser Product

Laser Light is different from any other light source with which you may be familiar with. This laser is less dangerous than a higher class laser such as an 3B or 4. The light from this product is safe for unintentional (<1/4 sec) unaided eye exposure. However this device is potentially hazardous if viewed with certain optical instruments such as binoculars or eye loupe.

Laser light is thousands of times more concentrated than light from any other kind of light source. This concentration of light power can cause instant eye injuries, primarily by burning the retina (the light sensitive portion at the back of the eye). Even if you cannot feel "heat" from a laser beam, it can still potentially injure or blind you or your audience.

Even very small amounts of laser light are potentially hazardous even at long distances. Laser eye injuries can happen quicker than you can blink.

It is incorrect to think that because these laser products split the laser into hundreds of beams or the laser beam is scanned out in high speed, that an individual laser beam is safe for eye exposure. This laser product uses dozens of milliwatts of laser power (Class 2M levels internally). Many of the individual beams are potentially hazardous to the eyes.

It is also incorrect to assume that because the laser light is moving, it is safe. This is not true. Nor, do the laser beams always move. Since eye injuries can occur instantly, it is critical to prevent the possibility of any direct eye exposure. According to the laser safety regulation, it is not legal to aim Class 2M lasers in areas which people can get exposed. This is true even if it is aimed below people's faces, such as on a dance floor.

CAUTION! Only Laser Safety Officers who are officially certified by a regulatory body or authorized training organization are allowed to use class 2M lasers in public. Whether a Laser Safety Officer is required depends on national legislation. The Laser Safety Officer is responsible for all aspects when using this laser, including following all locally applicable safety laws and regulations. The manufacturer will not accept liability for damages caused by the misuse or incorrect installation of this laser.



CAUTION: AVOID EXPOSURE TO BEAM: Avoid direct eye contact with laser light. Never intentionally expose your eyes or others to direct laser radiation.

Compliance Statement

Your Dynamica Laser has been designed to comply with FDA and IEC Standards for its classification. The Dynamica is a Class 2M laser product.

Laser Safety and Compliance Information

The Dynamica is manufactured to comply with the IEC 60825-1 and in accordance with U.S. Food and Drug Administration (FDA) Standards Listed under FDA Document 21 CFR 1040 and subsequent laser notices.

Product Classification and Manufacturing Label Identification

Laser Classification	Class 2M
Cooling	Cooling fans and TE Cooling
Laser medium	wavelength 650 nm / Red (Laser Diode GaAlAs) ; Output >2x100mW wavelength 532 nm / Green (DPSS Nd: YVO4); Output >2x30mW
Output	260mW
Beam Diameter	<5mm at aperture
Pulse Data All pulses	< 4Hz (>0.25sec)
Divergence (each beam)	<2 mrad
Divergence (total light)	<160 degrees

The legal requirements for using laser entertainment products vary from country to country. The user is responsible for the legal requirements at the location/country of use.

Further guidelines and safety programs for safe use of lasers can be found in the ANSI Z136.1 Standard "For Safe Use of Lasers", available from www.lia.org/. Many local governments, corporations, agencies, military and others, require all lasers to be used under the guidelines of ANSI Z136.1. Laser Display guidance can be obtained via the International Laser Display Association, www.ilda.com/index.htm.

CAUTION: The use of corrective eye wear or optics for viewing at distances such as telescopes or binoculars within a distance of 100mm may pose an eye hazard.



This laser product is a Class 2M laser and has an interlocked housing.



There are no user serviceable parts inside. Tampering or removing warranty seals will void your products limited warranty.



Combo label with the Product Model Number, Serial Number, Date of Manufacturing, Laser Light Warning Label, Warranty Void Label and Interlocked Housing Label

Proper Usage Safety and Compliance Information

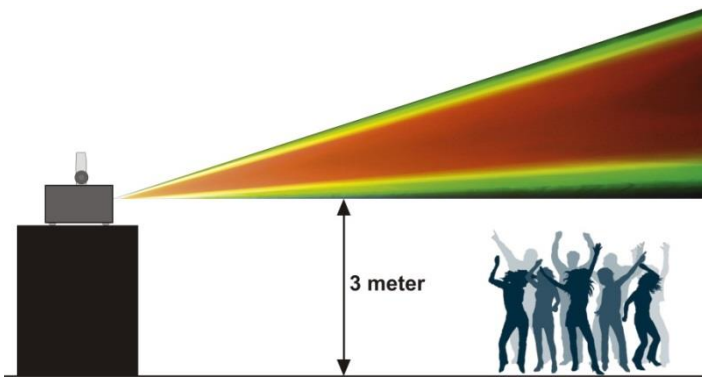

According to FDA Regulations you should operate this product as stated on the left.

Rigging

Please follow the European and national guidelines concerning rigging, trussing and all other safety issues.

Do not attempt the installation yourself !

Always let the installation be carried out by an authorized dealer !

Procedure:

- If the Dynamica is lowered from the ceiling or high joists, professional trussing systems have to be used.
- Use a clamp to mount the Dynamica, with the mounting bracket, to the trussing system.
- The Dynamica must never be fixed swinging freely in the room.
- The installation must always be secured with a safety attachment, e.g. an appropriate safety net or safety cable.
- When rigging, derigging or servicing the Dynamica, always make sure, that the area below the installation site is secured and that there are not any unauthorized people around.

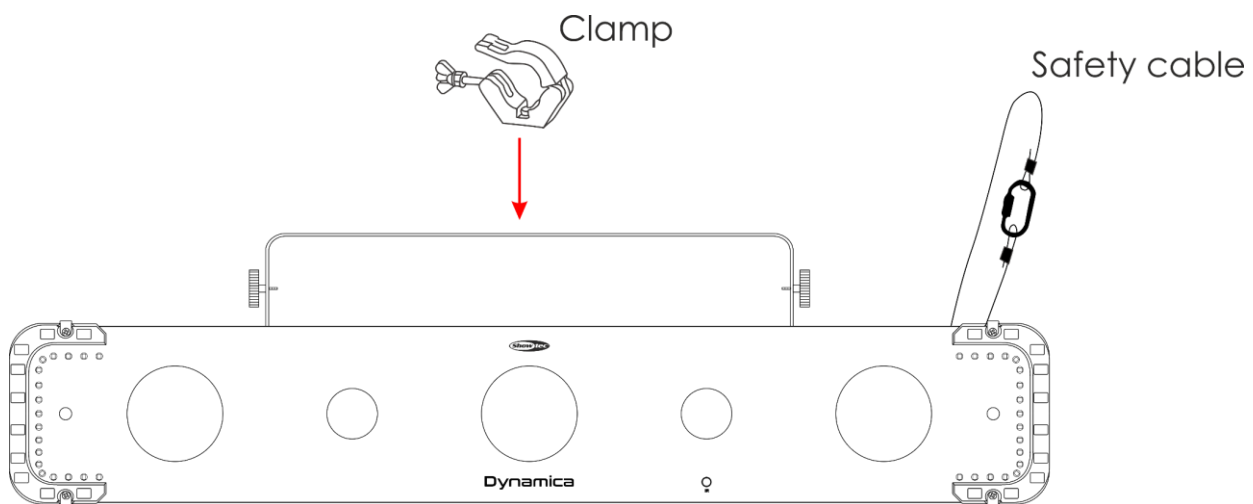

The Dynamica can be placed on a flat stage floor or mounted to any kind of truss with a clamp.

Improper installation can cause serious injuries and/or damage of property!

Connection with the mains

Connect the device to the mains with the power-plug.
Always check if the right color cable is connected to the right place.

International	EU Cable	UK Cable	US Cable	Pin
L	BROWN	RED	YELLOW/COPPER	PHASE
N	BLUE	BLACK	SILVER	NEUTRAL
	YELLOW/GREEN	GREEN	GREEN	PROTECTIVE GROUND

Make sure that the device is always properly connected to the earth!

Improper installation can cause serious injuries and/or damage of property!



⚠ Return Procedure ⚠

Returned merchandise must be sent prepaid and in the original packing, call tags will not be issued. Package must be clearly labeled with a Return Authorization Number (RMA number). Products returned without an RMA number will be refused. Highlite will not accept the returned goods or any responsibility. Call Highlite 0031-455667723 or mail aftersales@highlite.nl and request an RMA prior to shipping the fixture. Be prepared to provide the model number, serial number and a brief description of the cause of the return. Be sure to properly pack fixture as any shipping damage resulting from inadequate packaging is the customer's responsibility. Highlite reserves the right to use its own discretion to repair or replace product(s). As a suggestion, proper UPS packing or double-boxing is always a safe method to use.

Note: If you are given an RMA number, please include the following information on a piece of paper inside the box:

- 01) Your name.
- 02) Your address.
- 03) Your phone number.
- 04) A brief description of the symptoms.

Claims

The client has the obligation to check the delivered goods immediately upon delivery for any shortcomings and/or visible defects, or perform this check after our announcement that the goods are at their disposal. Damage incurred in shipping is the responsibility of the shipper; therefore the damage must be reported to the carrier upon receipt of merchandise.

It is the customer's responsibility to notify and submit claims with the shipper in the event that the fixture is damaged due to shipping. Transportation damage has to be reported to us within one day after receipt of the delivery.

Any return shipment has to be made post-paid at all times. Return shipments must be accompanied with a letter defining the reason for return shipment. Non-prepaid return shipments will be refused, unless agreed otherwise in writing.

Complaints against us must be made known in writing or by fax within 10 working days after receipt of the invoice. After this period, complaints will not be handled anymore.

Complaints will only be considered if the client has so far complied with all parts of the agreement, regardless of the agreement of which the obligation is resulting.

Description of the device

Features

The Showtec Dynamica is an all-in-one light effect. It combines RGBWA LED beam effects with 2 RG grating lasers, UV wash and 2 SMD strobe arrays. It has 2, 5, 8 and 10 channel DMX modes to offer basic operation and full control of all individual effects. On board built-in programs both combined and alternating effects can be applied in sound or auto mode. Multiple units can be daisy chained with both DMX and IEC power linking, and controlled in master slave mode. The Dynamica has an extreme wide floor coverage and is the ideal all in one solution for Musicians, DJ's, Clubs and Mobile applications.

- 4-in-1 light effect
- Dual RG Laser Grating effects
- RGBWA LED Pattern beams
- Strobe arrays & UV
- Input voltage: 100-240V AC, 50/60Hz
- Power consumption: 40W (full output)
- DMX channels: 2, 5, 8 or 10 channels
- 4-digit LED display for easy setup
- Control modes: Auto, Sound-controlled, Master/Slave, DMX
- Control protocol: DMX-512
- Protection rate: IP-20
- Housing: Die-cast black aluminum
- Cooling: Fans/Convection
- Connections: IEC connectors (IN/OUT), 3-pin XLR (IN/OUT)
- Fuse: T1.6L/250V
- Dimensions: 770 x 175 x 225 mm (LxWxH) (incl. bracket)
- Weight: 5,5 kg

LED Beam effect

- Colors: RGBWA
- Light source: 192 x 0,12W LEDs

Laser effect

- Laser Color: 2xRed, 2xGreen
- Laser Power: 260mW (2x100mW 650nm Red, 2x30mW 532nm Green)
- Laser Class: 2M
- Safety Features: Key switch, Interlock, Safety eye
- Laser Safety: EN/IEC 60825-1 Ed 2, 2007-03

Strobe effect

- Light source: 18 x 0,5W Cool white LEDs

UV effect

- Light source: 2 x 3W LEDs

Note: Knowledge of DMX is required to fully utilize this unit.

Optional accessories

[51316](#) Remote Interlock

Frontside

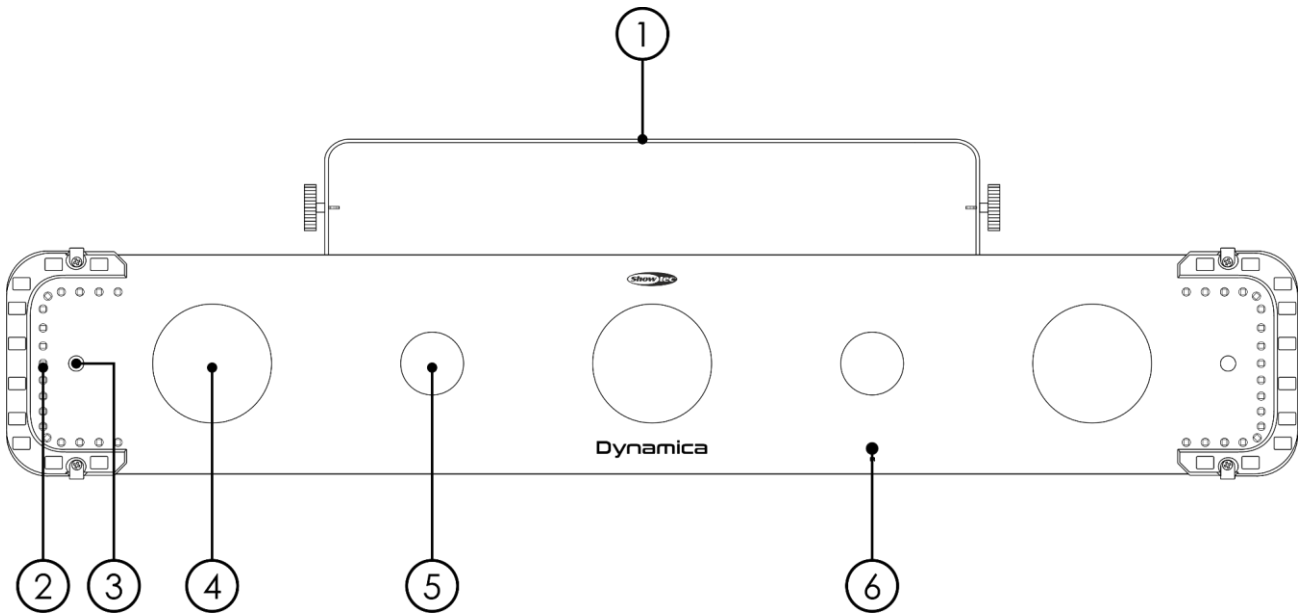

Fig. 01

- 01) Mounting bracket incl. adjustment screws
- 02) Strobe: 18 x 0,5W Cool white LEDs
- 03) Laser lens
- 04) Beam: 192 x 0,12W LEDs
- 05) UV: 2 x 3W LEDs
- 06) IR-remote sensor

Backside

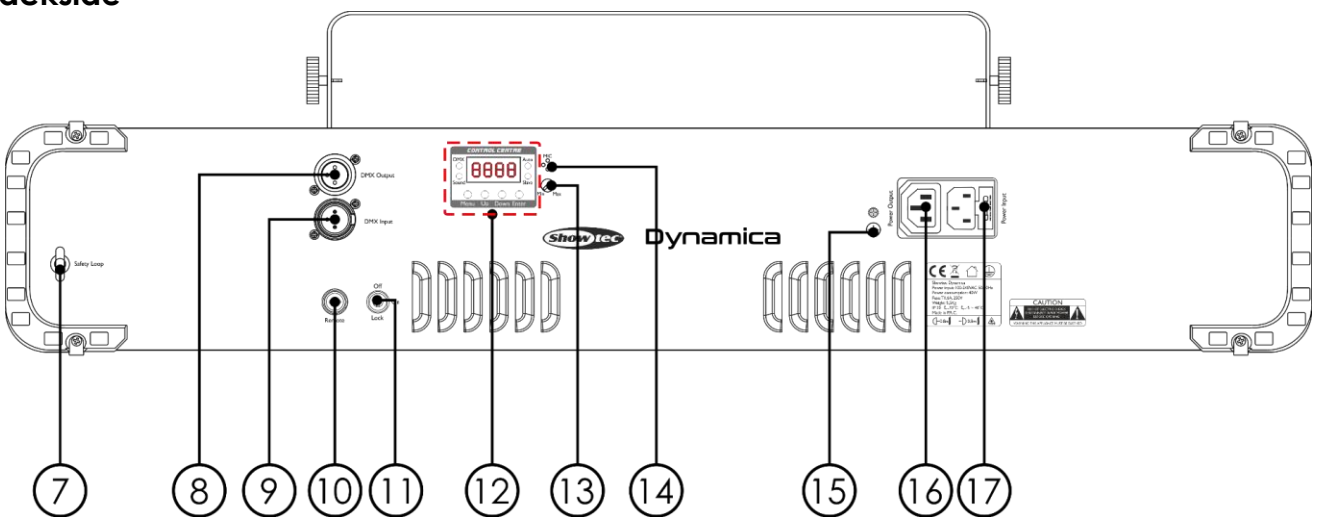

Fig. 02

- 07) Safety eye
- 08) 3-pin DMX signal connector OUT
- 09) 3-pin DMX signal connector IN
- 10) Remote control plug
- 11) Interlock
- 12) LED display + menu buttons + Function LED indicators
- 13) Sound sensitivity control
- 14) Built-in microphone
- 15) Ground/earth connection
- 16) IEC Power connector OUT
- 17) IEC Power connector IN + Fuse T1.6L/250V

Installation

Remove all packing materials from the Dynamica. Check if all foam and plastic padding is removed. Connect all cables.

Do not supply power before the whole system is set up and connected properly.

Always disconnect from electric mains power supply before cleaning or servicing.

Damages caused by non-observance are not subject to warranty.

Set Up and Operation

Follow the directions below, as they pertain to your preferred operation mode.

Before plugging the unit in, always make sure that the power supply matches the product specification voltage. Do not attempt to operate a 120V specification product on 230V power, or vice versa.

Connect the device to the main power supply. The device can be sound-controlled as it is equipped with a built-in microphone.

The Interlock plug/remote plug and safety keys are included in the box.

The interlock is the "included-in-the-box" successor for the optional remote interlock ([51316](#)).

⚠ They should be kept with the Dynamica !!! ⚠

The following safety precautions should be followed:

- The remote control plug should be placed on the backside (10) of your Dynamica.
- The keys should be put into the lock (11) of your Dynamica.

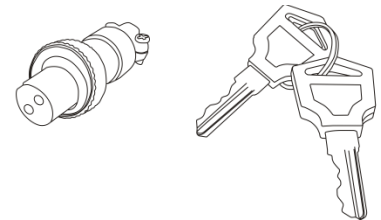

⚠ Warning ⚠

If the plug is not connected, your laser will not function.

If the key is not set to ON, your laser will not function.

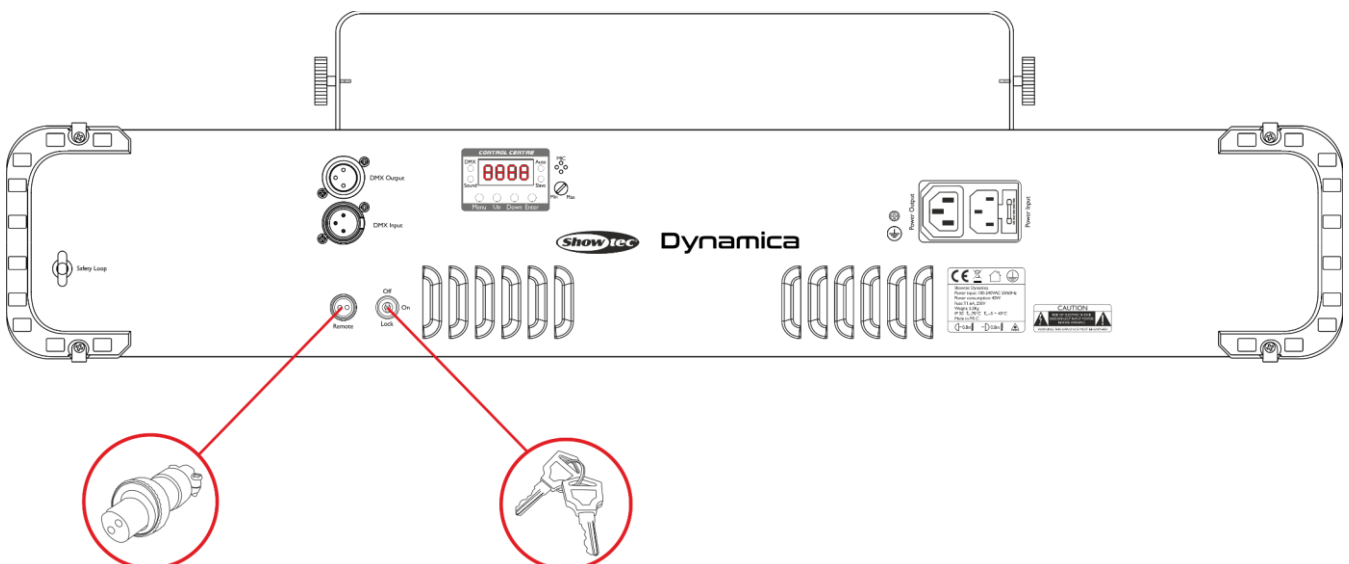

Fig. 03

Exclusion of liability

Be aware that in some countries, there are additional regulations, regarding the use of laser devices. Therefore, we strongly advise you to verify your national laws with your authorities: We do not take any responsibility for eventual discrepancies, changes or adaptations regarding lawful use of laser devices.

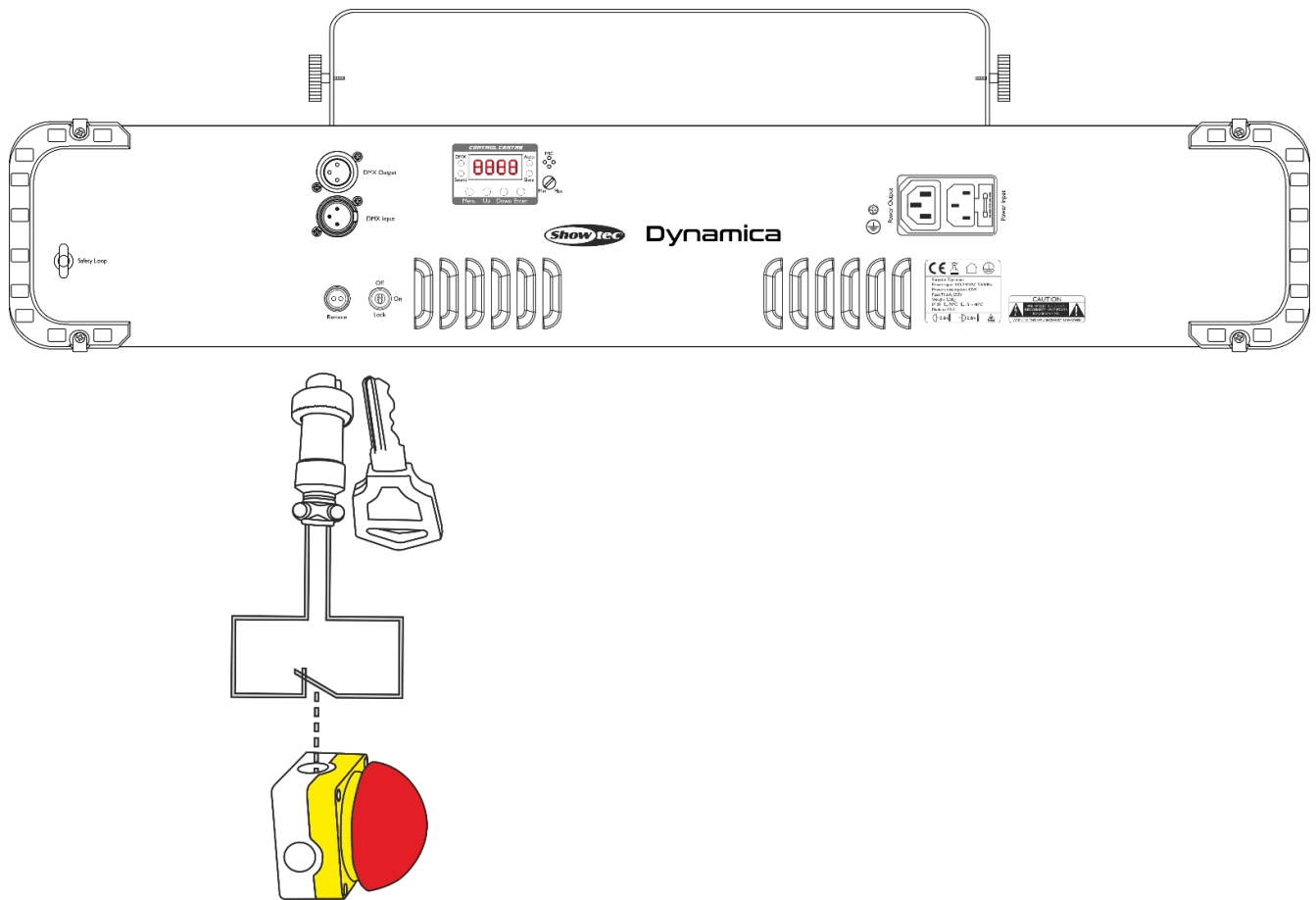

Fig. 04

Control Modes

There are 4 modes:

- Auto Programs
- Sound-controlled
- Master/slave
- DMX-512 (2CH, 5CH, 8CH or 10CH)

One Dynamica (Auto Programs)

- 01) Fasten the effect light to a firm trussing. Leave at least 0,5 meter on all sides for air circulation.
- 02) Always use a safety cable (ordercode 70140 / 70141).
- 03) Plug the end of the electric mains power cord into a proper electric power supply socket.
- 04) When the Dynamica is not connected with a DMX cable, it functions as a stand-alone device. Please see page 16 for more information about Auto Programs.

One Dynamica (Sound-controlled)

- 01) Fasten the effect light to a firm trussing. Leave at least 0,5 meter on all sides for air circulation.
- 02) Always use a safety cable (ordercode 70140 / 70141).
- 03) Plug the end of the electric mains power cord into a proper electric power supply socket.
- 04) Turn on the music. If the device is set to sound-control, then the Dynamica will react to the beat of the music. Please see page 17 for more information about the sound-control options.

Multiple Dynamicas (Master/Slave control)

- 01) Fasten the effect light onto firm trussing. Leave at least 0,5 meter on all sides for air circulation.
- 02) Always use a safety cable (ordercode 70140 / 70141).
- 03) Use a 3-p XLR cable to connect the Dynamicas and other devices.

The pins:



- 1. Earth
- 2. Signal (-)
- 3. Signal (+)

- 04) Link the units as shown in Fig. 05, connect a DMX signal cable from the first unit's DMX "out" socket to the second unit's "in" socket. Repeat this process to link the second and third units. You can use the same functions on the master device as described on page 16 (Auto). This means you can set your desired operation mode on the master device and all slave devices will react the same as the master device.

Multiple Dynamicas (Master/Slave control)

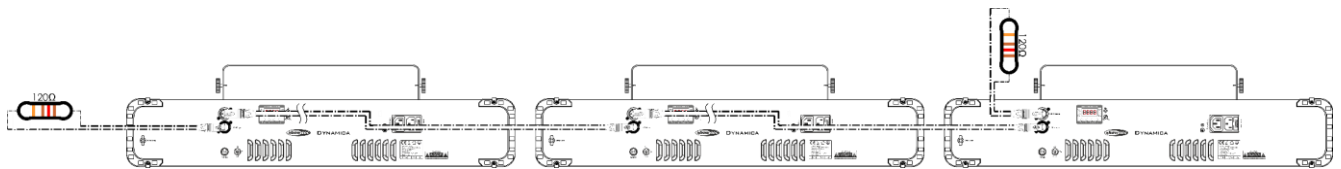
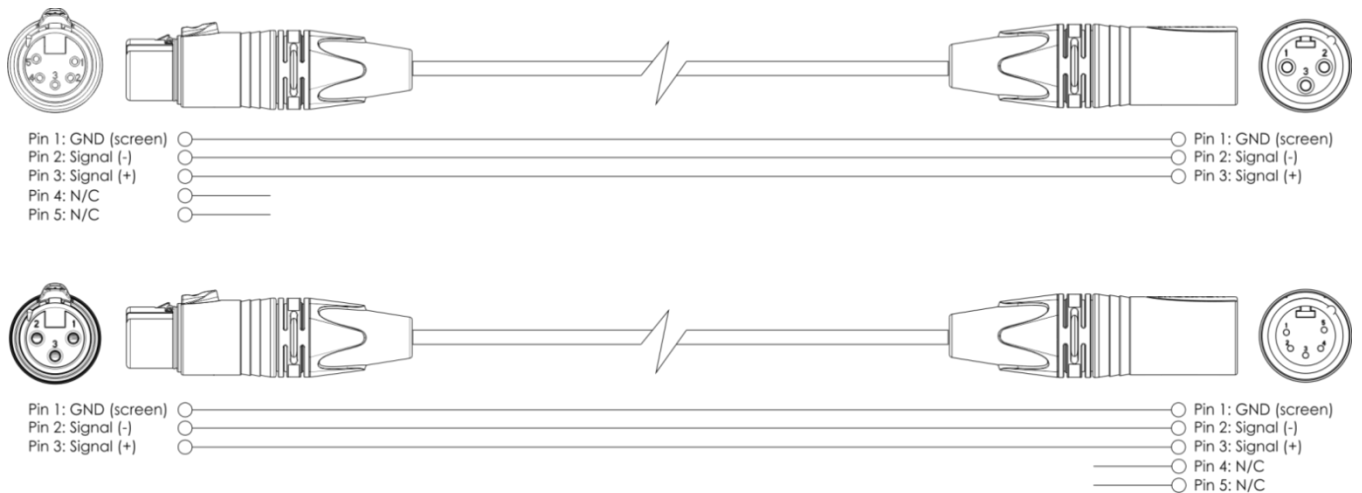

Fig. 05

Multiple Dynamicas (DMX Control)

- 01) Fasten the effect light to a firm trussing. Leave at least 0,5 meter on all sides for air circulation.
- 02) Always use a safety cable (ordercode 70140 / 70141).
- 03) Use a 3-pin XLR cable to connect the Dynamicas and other devices.



- 04) Link the units as shown in Fig. 06. Connect the first unit's DMX "out" socket with the second unit's "in" socket, using a DMX-signal cable. Repeat this process to link the second and third units.
- 05) Supply electric power: Plug electric mains power cords into each unit's IEC socket, then plug the other end of the mains power cord into proper electric power supply sockets, starting with the first unit. Do not supply power before the whole system is set up and connected properly.

Multiple Dynamicas DMX Set Up

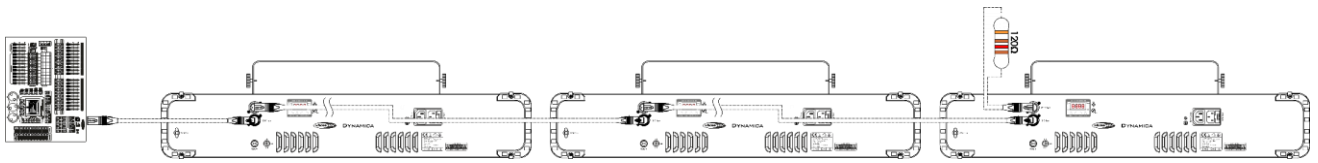

Fig. 06

Note: Link all cables before connecting electric power

Fixture Linking

You will need a serial data link to run light shows of one or more fixtures using a DMX-512 controller or to run synchronized shows of two or more fixtures set to a master/slave operating mode. The combined number of channels required by all the fixtures on a serial data link determines the number of fixtures the data link can support.

- Important:** Fixtures on a serial data link must be daisy-chained in a single line. To comply with the EIA-485 standard, no more than 30 devices should be connected on one data link. Connecting more than 30 fixtures on one serial data link without the use of a DMX optically isolated splitter may result in deterioration of the digital DMX signal.
- Maximum recommended DMX data link distance: 100 meters
 - Maximum recommended number of fixtures on a DMX data link: 30 fixtures
 - Maximum recommended number of fixtures on a power link @ 110V: 15 fixtures
 - Maximum recommended number of fixtures on a power link @ 240V: 30 fixtures



Data Cabling

To link fixtures together, you must obtain data cables. You can purchase DAP Audio certified DMX cables directly from a dealer/distributor or construct your own cable. If you choose to create your own cable, please use data-grade cables that can carry a high quality signal and are less prone to electromagnetic interference.

DAP Audio DMX Data Cables

- DAP Audio Basic microphone cable for allround use. bal. XLR/M 3-pin > XLR/F 3-pin. **Ordercode** FL01150 (1,5 m), FL013 (3 m), FL016 (6 m), FL0110 (10 m), FL0115 (15 m), FL0120 (20 m).
- DAP Audio X-type data cable XLR/M 3-pin > XLR/F 3-pin. **Ordercode** FLX0175 (0,75 m), FLX01150 (1,5 m), FLX013 (3 m), FLX016 (6 m), FLX0110 (10 m).
- DAP Audio cable for the demanding user with exceptional audio-qualities and connector made by Neutrik®. **Ordercode** FL71150 (1,5 m), FL713 (3 m), FL716 (6 m), FL7110 (10 m).
- DAP Audio cable for the demanding user with exceptional audio-qualities and connector made by Neutrik®. **Ordercode** FL7275 (0,75 m), FL72150 (1,5 m), FL723 (3 m), FL726 (6 m), FL7210 (10 m).
- DAP Audio 110 Ohm cable with digital signal transmission. **Ordercode** FL0975 (0,75 m), FL09150 (1,5 m), FL093 (3 m), FL096 (6 m), FL0910 (10 m), FL0915 (15 m), FL0920 (20 m).
- DAP Audio data cable FL08 DMX/AES-EBU, XLR/M 5-pin > XLR/F 5-pin. **Ordercode** FL08150 (1,5 m), FL083 (3 m), FL086 (6 m), FL0810 (10 m), FL0820 (20 m).
- DAP Audio DMX adapter: 5-pin/3-pin. **Ordercode** FLA29.
- DAP Audio DMX adapter: 3-pin/5-pin. **Ordercode** FLA30.

The Dynamica can be operated with a controller in **control mode** or without the controller in **stand-alone mode**.

Control Panel

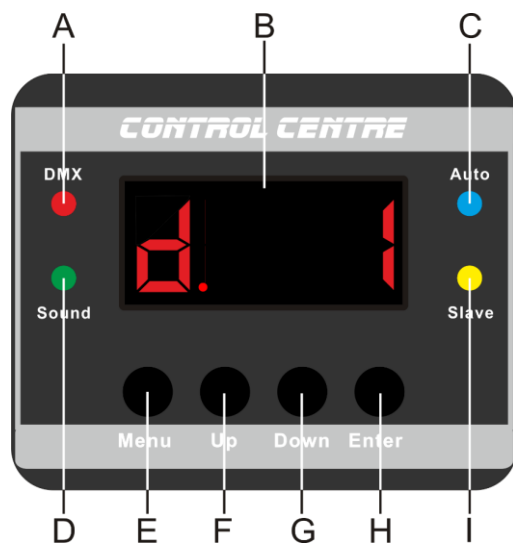

- A) DMX LED
- B) LED display
- C) Auto LED
- D) Sound LED
- E) Menu button
- F) Up button
- G) Down button
- H) Enter button
- I) Slave LED

Fig. 07

Control Mode

The fixtures are individually addressed on a data-link and connected to the controller. The fixtures respond to the DMX signal from the controller. (When you select the DMX address and save it, the controller will display the saved DMX address, next time.)

DMX Addressing

The control panel on the back side of the device allows you to assign DMX fixture addresses, which is the first channel with which the Dynamica will respond to the controller.

Please note, when you use the controller, the unit has **10** channels.

When using multiple Dynamicas, make sure you set the DMX addresses right.

Therefore, the DMX address of the first Dynamica should be **1(d001)**; the DMX address of the second Dynamica should be **1+10=11 (d011)**; the DMX address of the third Dynamica should be **11+10=21(d021)**, etc. Please, be sure that you do not have any overlapping channels in order to control each Dynamica correctly. If two or more Dynamicas are addressed similarly, they will work similarly.

Controlling:

After having addressed all Dynamica fixtures, you may now start operating these via your lighting controller.

Note: After switching on, the Dynamica will automatically detect whether DMX 512 data is received or not. If there is no data received, the problem may be:

- The XLR cable from the controller is not connected with the input of the Dynamica.
- The controller is switched off or defective, the cable or connector is defective, or the signal wires are swapped in the input connector.

Note: It is necessary to insert an XLR termination plug (with 120 Ohm) in the last fixture in order to ensure proper transmission on the DMX data link.

Display Off after 35 seconds

When no button is pressed for 35 seconds, the display will turn off in case this is set in the menu **System Settings**, see page 17 for more information.

To light up the display, you have to press the **Menu, Enter, Up** or **Down** button. Once you have pressed the button, the display will light up.

Menu Overview



The Dynamica will only show its version number at start-up !

U 100

Main Menu Options

- Aut** Auto Run Programs
- Sou** Sound-controlled Mode
- dM** DMX Channels / DMX Address
- SLA** Slave Mode
- SYS** System Settings

1. Auto Run Programs

With this menu you can start several Auto Run Programs.

- 01) Press the **Menu** button until the display shows **Aut**.
- 02) Press the **Enter** button to open the menu.
- 03) Press the **Up** and **Down** buttons to choose between 14 built-in programs **Au01** ^{Up/Down} **Au14**.
- 04) Choose the desired built-in program.
- 05) The Dynamica will immediately start the desired Auto run program.
- 06) Press the **Enter** button again to set the speed of the desired Auto run program.
- 07) Press the **Up** and **Down** buttons to adjust the speed between **S 1** ^{Up/Down} **S 100**, from slow to fast.



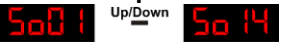

2. Sound-controlled Mode

With this menu you can choose several Sound-controlled programs.

- 01) Press the **Menu** button until the display shows **Sou**.
- 02) Press the **Enter** button to open the menu.
- 03) Press the **Up** and **Down** buttons to choose between 14 Sound-controlled programs

- 04) Choose the desired type and press the **Enter** button to confirm.
- 05) Turn on the music and the Dynamica will start the desired Sound-controlled program after a few seconds.

3. DMX Address / DMX Channels

With this menu you can choose a DMX configuration and set the DMX address.

- 01) Press the **Menu** button until the display shows **dMx**.
- 02) Press the **Enter** button, the display will show **d 1**.
- 03) Press the **Enter** button again to open the submenu.
- 04) Press the **Up** and **Down** buttons to choose between **02Ch**, **05Ch**, **08Ch** or **10Ch**.
- 05) Choose the desired configuration and press the **Enter** button to open the submenu.
- 06) Press the **Up** and **Down** buttons to set the desired DMX address.
- 07) If you choose the **02Ch** configuration, the adjustment range is between **d 1**  **d511**.
- 08) If you choose the **05Ch** configuration, the adjustment range is between **d 1**  **d508**.
- 09) If you choose the **08Ch** configuration, the adjustment range is between **d 1**  **d505**.
- 10) If you choose the **10Ch** configuration, the adjustment range is between **d 1**  **d503**.

4. Slave mode

With this menu you can set the device as a Slave.



- 01) Press the **Menu** button until the display shows **SLA**.
- 02) Press the **Enter** button to activate the slave mode, the display shows **SLAV**.
- 03) If the device has not been set to slave, it is automatically classified as a master device. All slave devices will follow the master movement. If the device has been set to slave, it will react the same as its master device.

5. System Settings

With this menu you can set several system functions.

- 01) Press the **Menu** button until the display shows **SYS**.
- 02) Press the **Enter** button to open this menu.
- 03) Press the **Up** and **Down** buttons to choose between 3 settings:

- LEdS** LED display on/off
- LEdr** LED display reverse
- rESt** Reset to default settings

- 04) If you have chosen **LEdS**, press the **Enter** button to set the LED display **ON** or **OFF**.
- 05) Press the **Up** and **Down** buttons to choose between **on**  **off**.
- 06) If you choose **off**, the display will continuously light up.
- 07) If you choose **on**, the display will turn off after 35 seconds, the display will show .
- 08) If you have chosen **LEdr**, press the **Enter** button to set the display in reverse mode.
- 09) Press the **Up** and **Down** buttons to choose between **off**  **on**.
- 10) If you choose **off**, the text will be displayed normally.

- 11) If you choose **on**, the text will be displayed reversed.
- 12) If you have chosen **RESET**, press the **Enter** button to reset to default settings.
- 13) Press the **Up** and **Down** buttons to choose between **no** ^{Up/Down} **YES**.
- 14) To reset the device choose **YES**.
- 15) Press the **Enter** button to confirm.
- 16) The display will show its version **V100** and the device settings have been reset.
- 17) The device will start up in the Auto Run Programs mode.

Remote Control

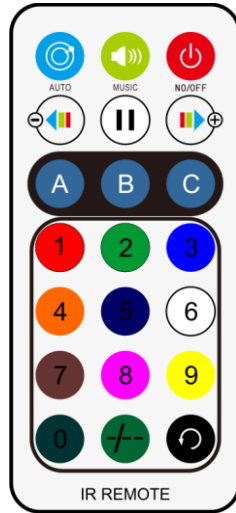

Note: buttons **A**, **B**, **C**, **||** and **+/-** have no function

Button	Function	Description
	On / Off	Switch the device ON or OFF
	Auto Run Mode	Repeatedly press the button to activate the Auto Run programs (Au01 ^{Up/Down} Au14)
	Sound-controlled Mode	Repeatedly press the button to activate the Sound-controlled programs (So01 ^{Up/Down} So14)
	Auto Speed	Press one of the buttons to adjust the auto speed. 0 = no rotation, 9 = fast
	Auto Run Programs Speed	Press one of the two buttons to change the speed of the desired Auto Run program slower or faster
	Auto/Sound mode switch	Press the button to change the programs between Auto or Sound mode

DMX Channels

2 channels

Channel 1 – Auto (CH2 must be set between 0-250 ) and

Sound Programs Beam LEDs/UV LEDs/Strobe LEDs/Laser (CH2 must be set between 251-255 )

0-5	No function
6-22	AUT1/SOU1 (SOU=sound)
23-40	AUT2/SOU2
41-58	AUT3/SOU3
59-76	AUT4/SOU4
77-94	AUT5/SOU5
95-112	AUT6/SOU6
113-129	AUT7/SOU7
130-147	AUT8/SOU8
148-165	AUT9/SOU9
166-183	AUT10/SOU10
184-201	AUT11/SOU11
202-219	AUT12/SOU12
220-237	AUT13/SOU13
238-255	AUT14/SOU14

Channel 2 – Speed Auto Programs/ Sensitivity Sound programs (CH1 must be set between 6-255 )

0-250	Gradual adjustment Speed Auto programs from slow to fast
251-255	Sound-controlled, from less sensitivity to maximum sensitivity

5 channels

Channel 1 – Auto (CH5 must be set between 0-250 ); for

Sound Programs UV LEDs (CH5 must be set between 251-255 )

0-5	No function
6-55	AP01/SP01 (SP=sound)
56-106	AP02/SP02
107-155	AP03/SP03
156-205	AP04/SP04
206-255	APM/SPM (mix programs)

Channel 2 – Auto (CH5 must be set between 0-250 ); for

Sound Programs Beam LEDs (CH5 must be set between 251-255 )

0-5	No function
6-13	AB01/SB01 (SB=sound)
14-21	AB02/SB02
22-29	AB03/SB03
30-37	AB04/SB04
38-45	AB05/SB05
46-53	AB06/SB06
54-61	AB07/SB07
62-69	AB08/SB08
70-77	AB09/SB09
78-85	AB10/SB10
86-93	AB11/SB11

94-101	AB12/SB12
102-109	AB13/SB13
110-117	AB14/SB14
118-125	AB15/SB15
126-133	AB16/SB16
134-141	AB17/SB17
142-149	AB18/SB18
150-157	AB19/SB19
158-165	AB20/SB20
166-173	AB21/SB21
174-181	AB22/SB22
182-189	AB23/SB23
190-197	AB24/SB24
198-205	AB25/SB25
206-213	AB26/SB26
214-221	AB27/SB27
222-229	AB28/SB28
230-237	AB29/SB29
238-245	AB30/SB30
246-255	ABM/SBM (mix programs)

Channel 3 – Auto (CH5 must be set between 0-250 ); for

Sound Programs Laser (CH5 must be set between 251-255 )

0-5	No function
6-40	AL01/SL01 (SL=sound)
41-76	AL02/SL02
77-112	AL03/SL03
113-147	AL04/SL04
148-183	AL05/SL05
184-219	AL06/SL06
220-255	ALM/SLM (mix programs)

Channel 4 – Auto (CH5 must be set between 0-250 ); for

Sound Programs Strobe LEDs (CH5 must be set between 251-255 )

0-5	No function
6-27	AF01/SF01 (SF=sound)
28-50	AF02/SF02
51-73	AF03/SF03
74-95	AF04/SF04
96-118	AF05/SF05
119-141	AF06/SF06
142-163	AF07/SF07
164-186	AF08/SF08
187-209	AF09/SF09
210-232	AF10/SF10
233-255	AFM/SFM (mix programs)

Channel 5 – Speed Auto Programs/ Sensitivity Sound programs UV/Beam/Laser/Strobe

(CH1, CH2, CH3 or CH4 must be set between 6-255 )

0-250	Gradual adjustment Speed Auto programs from slow to fast
251-255	Sound-controlled, from less sensitivity to maximum sensitivity

8 channels

Channel 1 – UV LED 1+2 Dimmer intensity/Strobe UV LEDs

0-128	Gradual adjustment UV from 0-100%
129-255	Strobe flash frequency, from slow to fast

Channel 2 – Auto and Sound Programs Beam LEDs

(For sound modus CH8 must be set between 36-71, 142-176 or 212-255 )

0-5	No function
6-13	AB01/SB01 (SB=sound)
14-21	AB02/SB02
22-29	AB03/SB03
30-37	AB04/SB04
38-45	AB05/SB05
46-53	AB06/SB06
54-61	AB07/SB07
62-69	AB08/SB08
70-77	AB09/SB09
78-85	AB10/SB10
86-93	AB11/SB11
94-101	AB12/SB12
102-109	AB13/SB13
110-117	AB14/SB14
118-125	AB15/SB15
126-133	AB16/SB16
134-141	AB17/SB17
142-149	AB18/SB18
150-157	AB19/SB19
158-165	AB20/SB20
166-173	AB21/SB21
174-181	AB22/SB22
182-189	AB23/SB23
190-197	AB24/SB24
198-205	AB25/SB25
206-213	AB26/SB26
214-221	AB27/SB27
222-229	AB28/SB28
230-237	AB29/SB29
238-245	AB30/SB30
246-255	ABM/SBM (mix programs)

Channel 3 – Speed Auto programs Beam LEDs (CH2 must be set between 6-255)

0-255	Gradual adjustment Speed Auto programs from slow to fast
-------	--

Channel 3 – Strobe Laser (CH4 must be set between 6-255)

0-255	Strobe flash frequency, from slow to fast
-------	---

Channel 4 – Laser functions

(when CH4 is set between 129-255, CH3 must be set between 1-255 )

(For sound modus CH8 must be set between 72-106, 142-176 or 212-255 )

0-5	No function
6-48	Red laser on
49-89	Green laser on
90-131	Red + Green laser on
132-173	Red laser flashes + Green laser on
174-215	Red laser on + Green laser flashes
216-255	Red + Green laser flash

Channel 5 – Speed laser

0	No function
1-127	Clockwise rotation, from slow to fast
128	Stop
129-255	Counterclockwise rotation, from slow to fast

Channel 6 – Auto and Sound Programs Strobe LEDs

(For sound modus CH8 must be set between 107-141, 177-211 or 212-255 )

0-5	No function
6-27	AF01/SF01 (SF=sound)
28-50	AF02/SF02
51-73	AF03/SF03
74-95	AF04/SF04
96-118	AF05/SF05
119-141	AF06/SF06
142-163	AF07/SF07
164-186	AF08/SF08
187-209	AF09/SF09
210-232	AF10/SF10
233-255	AFM/SFM (mix programs)

Channel 7 – Speed Auto Programs Strobe LEDs (CH6 must be set between 6-255 )

0-255	Gradual adjustment Speed Auto programs from slow to fast
-------	--

Channel 8 – Sound Programs (Beam LEDs/Laser/Strobe)

0-35	No function
36-71	Beam LEDs Sound mode (Laser & Strobe follow speed setting channels)
72-106	Laser Sound mode (Beam LEDs & Strobe follow speed setting channels)
107-141	Strobe Sound mode (Beam LEDs & Laser follow speed setting channels)
142-176	Beam LEDs & Laser Sound mode (Strobe follows speed setting channels)
177-211	Strobe & Laser Sound mode (Beam LEDs follows speed setting channels)
212-255	Beam LEDs & Strobe & Laser Sound mode

10 channels

Channel 1 – UV LED 1 Dimmer intensity

0-255 Gradual adjustment UV from 0-100%

Channel 2 – UV LED 2 Dimmer intensity

0-255 Gradual adjustment UV from 0-100%

Channel 3 – Strobe UV LEDs (CH1 or CH2 must be set between 1-255)

0-250 Strobe flash frequency, from slow to fast

251-255 Sound-activated strobe

Channel 4 – Auto (CH5 must be set between 0-250) ; for

Sound Programs Beam LEDs (CH5 must be set between 251-255)

0-5 No function

6-13 AB01/SB01 (SB=sound)

14-21 AB02/SB02

22-29 AB03/SB03

30-37 AB04/SB04

38-45 AB05/SB05

46-53 AB06/SB06

54-61 AB07/SB07

62-69 AB08/SB08

70-77 AB09/SB09

78-85 AB10/SB10

86-93 AB11/SB11

94-101 AB12/SB12

102-109 AB13/SB13

110-117 AB14/SB14

118-125 AB15/SB15

126-133 AB16/SB16

134-141 AB17/SB17

142-149 AB18/SB18

150-157 AB19/SB19

158-165 AB20/SB20

166-173 AB21/SB21

174-181 AB22/SB22

182-189 AB23/SB23

190-197 AB24/SB24

198-205 AB25/SB25

206-213 AB26/SB26

214-221 AB27/SB27

222-229 AB28/SB28

230-237 AB29/SB29

238-245 AB30/SB30

246-255 ABM/SBM (mix programs)

Channel 5 – Speed Auto Programs/ Sensitivity Sound programs (CH4 must be set between 6-255)

0-250 Gradual adjustment Speed Auto programs from slow to fast

251-255 Sound-controlled, from less sensitivity to maximum sensitivity

Channel 6 – Laser functions (when CH6 is set between 129-255, CH7 must be set between 6-255 )

0-5	No function
6-48	Red laser on
49-89	Green laser on
90-131	Red + Green laser on
132-173	Red laser flashes + Green laser on
174-215	Red laser on + Green laser flashes
216-255	Red + Green laser flash

Channel 7 – Strobe Laser (CH6 must be set between 6-255 )

0-5	No function
6-250	Strobe flash frequency, from slow to fast
251-255	Sound-activated strobe

Channel 8 – Speed laser

0	No function
1-127	Clockwise rotation, from slow to fast
128	Stop
129-255	Counterclockwise rotation, from slow to fast

Channel 9 – Auto (CH10 must be set between 0-250 ) ; for

Sound Programs Strobe LEDs (CH10 must be set between 251-255 )

0-5	No function
6-27	AF01/SF01 (SF=sound)
28-50	AF02/SF02
51-73	AF03/SF03
74-95	AF04/SF04
96-118	AF05/SF05
119-141	AF06/SF06
142-163	AF07/SF07
164-186	AF08/SF08
187-209	AF09/SF09
210-232	AF10/SF10
233-255	AFM/SFM (mix programs)

Channel 10 – Speed Auto Programs/ Sensitivity Sound programs Strobe LEDs

(CH9 must be set between 6-255 )

0-250	Gradual adjustment Speed Auto programs from slow to fast
251-255	Sound-controlled, sensitivity from less to maximum sensitivity

Maintenance

The Dynamica requires almost no maintenance. However, you should keep the unit clean. Otherwise, the fixture's light-output will be significantly reduced. Disconnect the mains power supply, and then wipe the cover with a damp cloth. Do not immerse in liquid. Wipe lens clean with glass cleaner and a soft cloth. Do not use alcohol or solvents.

The front lens will require weekly cleaning, as smoke-fluid tends to build up residues, reducing the light-output very quickly.

Keep connections clean. Disconnect electric power, and then wipe the DMX and audio connections with a damp cloth. Make sure connections are thoroughly dry before linking equipment or supplying electric power.

The operator has to make sure that safety-related and machine-technical installations are to be inspected by an expert after every year in the course of an acceptance test.

The operator has to make sure that safety-related and machine-technical installations are to be inspected by a skilled person once a year.

The following points have to be considered during the inspection:

- 01) All screws used for installing the device or parts of the device have to be tightly connected and must not be corroded.
- 02) There may not be any deformations on housings, fixations and installation spots.
- 03) Mechanically moving parts like axles, eyes and others may not show any traces of wearing.
- 04) The electric power supply cables must not show any damages or material fatigue.

Replacing the Fuse

Power surges, short-circuit or inappropriate electrical power supply may cause a fuse to burn out.

If the fuse burns out, the product will not function whatsoever. If this happens, follow the directions below:

- 01) Unplug the unit from electric power source.
- 02) Insert a flat-headed screwdriver into a slot in the fuse cover. Gently pry up the fuse cover. the fuse will come out.
- 03) Remove the used fuse. If brown or unclear, it is burned out.
- 04) Insert the replacement fuse into the holder. Reinsert the fuse cover. Be sure to use a fuse of the same type and specification. See the product specification label for details.

Troubleshooting

This troubleshooting guide is meant to help solve simple problems.

If a problem occurs, carry out the steps below in sequence until a solution is found. Once the unit operates properly, do not carry out following steps.

No Light

If the light effect does not operate properly, refer servicing to a technician.

Suspect four potential problem areas as: the power supply, the Laser, LEDs, the fuse.

- 01) Power supply. Check that the unit is plugged into an appropriate power supply.
- 02) The laser. Return the Dynamica to your Showtec dealer.
- 03) The LEDs. Return the Dynamica to your Showtec dealer.
- 04) The fuse. Replace the fuse. See page 25 for replacing the fuse.
- 05) If all of the above appears to be O.K., plug the unit in again.
- 06) If you are unable to determine the cause of the problem, do not open the Dynamica, as this may damage the unit and the warranty will become void.
- 07) Return the device to your Showtec dealer.

No Response to DMX

Suspect the DMX cable or connectors, a controller malfunction, a light effect DMX card malfunction.

- 01) Check the DMX setting. Make sure that DMX addresses are correct.
- 02) Check the DMX cable: Unplug the unit; change the DMX cable; then reconnect to electrical power. Try your DMX control again.
- 03) Determine whether the controller or light effect is at fault. Does the controller operate properly with other DMX products? If not, take the controller in for repair. If so, take the DMX cable and the light effect to a qualified technician.

The fixture does not work, no laser and the fan does not work

- 01) Check the connected power and main fuse.
- 02) Check the mains voltage on the main connector.

The fixture is power on, but no laser coming out from aperture

- 01) Check the laser aperture cover.
- 02) Check the key switch.
- 03) Check the remote interlock or interlock connector.
- 04) Wait for at least 30 minutes to warm up in low temperature.
- 05) Check whether the fixture is in music mode without sound signal.
- 06) Check whether the fixture is in Slave mode.
- 07) Check whether the fixture is in DMX mode without a DMX signal being present.

The laser effect power is very weak

- 01) Wait for at least 30 minutes to warm up in low temperature.
- 02) Clean the scanner mirror with alcohol.
- 03) Clean the aperture glass with alcohol.
- 04) Check whether the fixture it is in DMX mode with a high strobe frequency.

The laser is on, but the pattern is not moving

- 01) Check to see whether the fixture is in Music/Sound mode without detecting sound signal.
- 02) Check to see whether the fixture is in DMX mode.
- 03) Try to change the fixture to another stand-alone mode.
- 04) Try to control the fixture via DMX to see the laser effect system.

Problem	Probable cause(s)	Solution
One or more fixtures do not function at all	No power to the fixture	<ul style="list-style-type: none"> • Check if power is switched on and cables are plugged in
	Primary fuse blown.	<ul style="list-style-type: none"> • Replace fuse.
Fixtures reset correctly, but all respond erratically or not at all to the controller	The controller is not connected.	<ul style="list-style-type: none"> • Connect controller.
	3-pin XLR Out of the controller does not match XLR Out of the first fixture on the link (i.e. signal is reversed)	<ul style="list-style-type: none"> • Install a phase reversing cable between the controller and the first fixture on the link
Fixtures reset correctly, but some respond erratically or not at all to the controller	Poor data quality	<ul style="list-style-type: none"> • Check data quality. If much lower than 100 percent, the problem may be a bad data link connection, poor quality or broken cables, missing termination plug, or a defective fixture disturbing the link
	Bad data link connection	<ul style="list-style-type: none"> • Inspect connections and cables. Correct poor connections. Repair or replace damaged cables
	Data link not terminated with 120 Ohm termination plug	<ul style="list-style-type: none"> • Insert termination plug in output jack of the last fixture on the link
	Incorrect addressing of the fixtures	<ul style="list-style-type: none"> • Check address setting
	One of the fixtures is defective and disturbs data transmission on the link	<ul style="list-style-type: none"> • Bypass one fixture at a time until normal operation is restored: unplug both connectors and connect them directly together. • Have the defective fixture serviced by a qualified technician
	3-pin XLR Out on the fixtures does not match (pins 2 and 3 reversed)	<ul style="list-style-type: none"> • Install a phase-reversing cable between the fixtures or swap pin 2 and 3 in the fixture that behaves erratically
Shutter closes suddenly	The laser diode has lost its index position and the fixture is resetting the effect.	<ul style="list-style-type: none"> • Contact a technician for servicing the problem persists.
No light or LEDs or Laser cuts out intermittently	Fixture is too hot	<ul style="list-style-type: none"> • Allow the fixture to cool down • Clean the fan • Make sure air vents in control panel and the front lens are not blocked • Turn up the air conditioning
	LEDs or Laser damaged	<ul style="list-style-type: none"> • Disconnect the fixture and return it to your dealer
	The power supply settings do not match local AC voltage and frequency	<ul style="list-style-type: none"> • Disconnect fixture. Check settings and correct if necessary

Product Specifications

Model:	Showtec Dynamica
Input Voltage:	100-240V AC, 50/60Hz
Power consumption:	40W (full output)
DMX linking:	30 pcs
Power linking @110V	15 pcs
Power linking @240V	30 pcs
Protection rate:	IP-20
Fuse:	T1.6L/250V
Dimensions:	770 x 175 x 225 mm (LxWxH)
Weight:	5,5 kg
Operating and Programming:	
Signal pin OUT:	Pin 1 (earth), pin 2 (-), pin 3 (+)
DMX Mode:	2, 5, 8 or 10 channels
Signal input:	3-pin DMX IN
Signal output:	3-pin DMX OUT
Electro-mechanical effects:	
LED Beam effect:	192 x 0,12W RGBWA LEDs
Laser effect:	Colors: Red, Green Power: 260mW (2x100mW 650nm Red, 2x30mW 532nm Green) Class: 2M Safety Features: Key switch, Interlock, Safety eye Safety: EN/IEC 60825-1 Ed 2, 2007-03
Strobe effect:	18 x 0,5W Cool white LEDs
UV effect:	2 x 3W LEDs
Housing:	Die-cast black aluminum
DMX-control:	via standard DMX-controller
On Board:	4-digit LED display for easy setup
Control:	Auto, Sound-controlled, Master/Slave, DMX
Connections:	IEC connectors (IN/OUT), 3-pin XLR (IN/OUT)
Cooling:	Fans/Convection
Max. ambient temperature t_a :	40°C
Max. housing temperature t_B :	80°C
Minimum distance:	
Minimum distance from flammable surfaces:	0,5 m
Minimum distance to lighted object:	1 m

Design and product specifications are subject to change without prior notice.



Website: www.Showtec.info
Email: service@highlite.nl

Dimensions

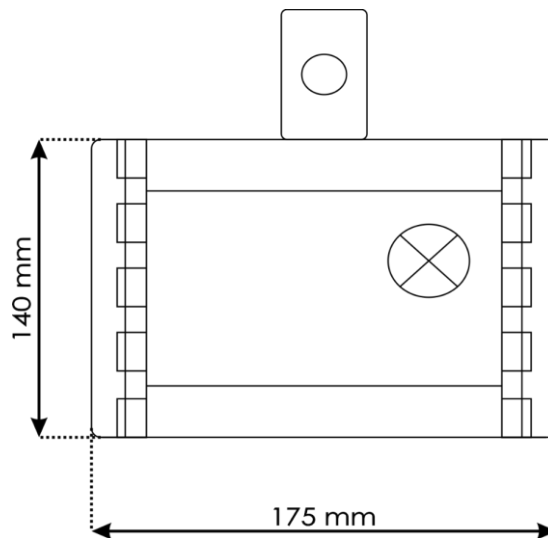
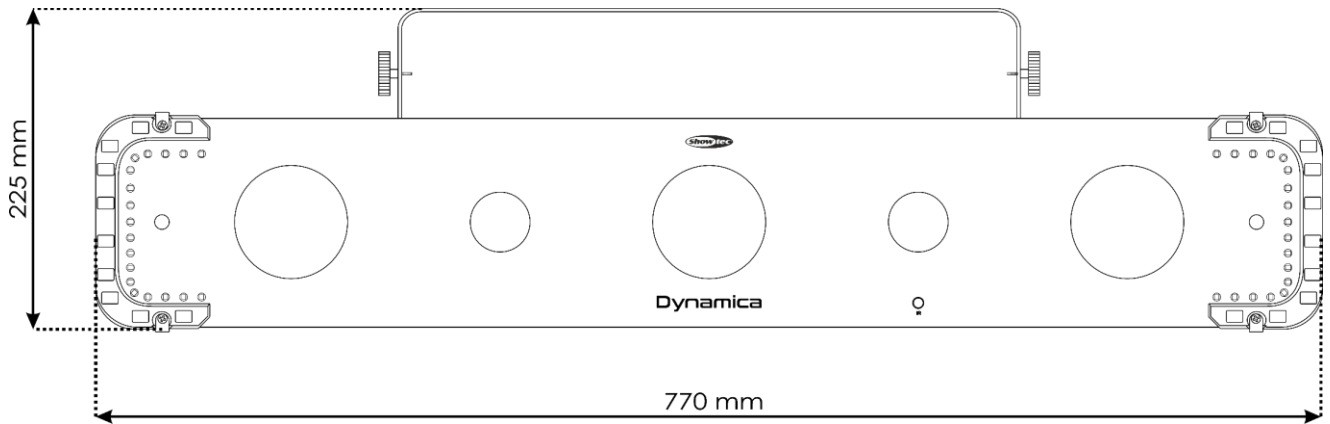



©2018 Showtec