

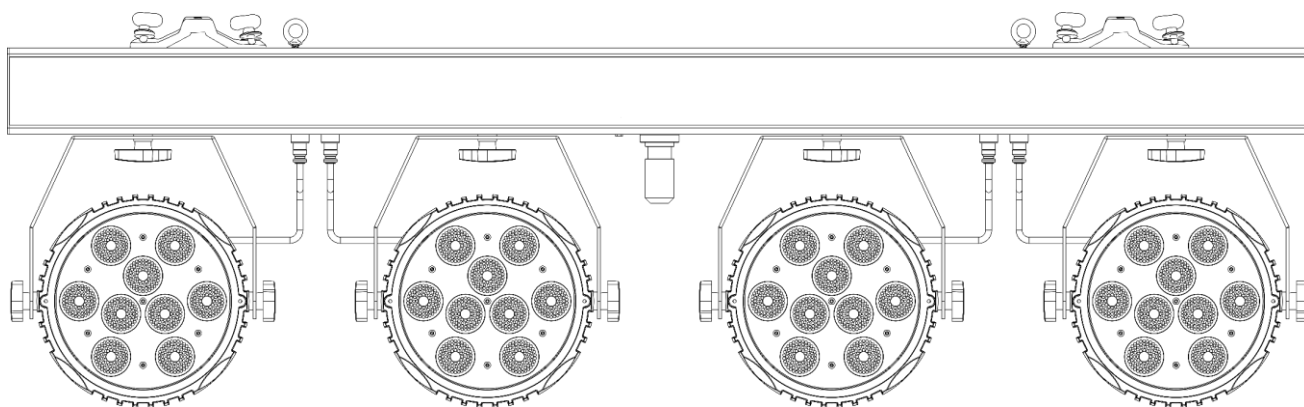

USER MANUAL



ENGLISH

Lightset PRO 9/10 RGBM V1

Product code: 30290

Preface

Thank you for purchasing this Showtec product.

The purpose of this user manual is to provide instructions for the correct and safe use of this product.

Keep the user manual for future reference as it is an integral part of the product. The user manual shall be stored at an easily accessible location.

This user manual contains information concerning:

- Safety instructions
- Intended and non-intended use of the device
- Installation and operation of the device
- Maintenance procedures
- Troubleshooting
- Transport, storage and disposal of the device

Non-observance of the instructions in this user manual may result in serious injuries and damage of property.

©2020 Showtec. All rights reserved.

No part of this document may be copied, published or otherwise reproduced without the prior written consent of Highlite International.

Design and product specifications are subject to change without prior notice.

For the latest version of this document, please visit our website www.highlite.com or contact us at service@highlite.com.

Highlite International and its authorized service providers are not liable for any injury, damage, direct or indirect loss, consequential or economic loss or any other loss arising from the use of, or inability to use or reliance on the information contained in this document.

Table of contents

1. Introduction.....	4
1.1. Before Using the Product	4
1.2. Intended Use	4
1.3. Product Lifespan.....	4
1.4. LEDs Lifespan	4
1.5. Text Conventions	4
1.6. Symbols and Signal Words.....	5
1.7. Symbols on the Information Label	5
2. Safety	6
2.1. Warnings and Safety Instructions	6
2.2. Requirements for the User.....	8
3. Description of the Device	9
3.1. Front View	9
3.2. Back View	10
3.3. Side View	10
3.4. Product Specifications	11
3.5. Optional Accessories.....	12
3.6. Dimensions.....	12
4. Installation	13
4.1. Safety Instructions for Installation	13
4.2. Personal Protective Equipment	13
4.3. Installation Site Requirements	13
4.4. Rigging	13
4.4.1. Angle Adjustment.....	15
4.5. Beamshaper Installation	15
4.6. Connecting to Power Supply.....	16
4.7. Power Linking of Multiple Devices.....	16
5. Setup	17
5.1. Warnings and Precautions	17
5.2. Stand-alone Setup	17
5.3. DMX Connection.....	17
5.3.1. DMX-512 Protocol.....	17
5.3.2. DMX Cables.....	18
5.3.3. Master/Slave Setup	18
5.3.4. DMX Linking.....	19
5.3.5. DMX Addressing.....	19
6. Operation	20
6.1. Safety Instructions for Operation	20
6.2. Control Modes	20
6.3. Control Panel	21
6.4. Start-up.....	21
6.5. Menu Overview	22
6.6. Main Menu Options	24
6.6.1. DMX Settings.....	24
6.6.1.1. Address.....	25
6.6.1.2. Channels.....	25
6.6.2. Manual Mode	25
6.6.2.1. Color Preset	26
6.6.2.2. Color All.....	26
6.6.2.3. Color Pixel	26
6.6.3. Auto.....	27
6.6.4. Program.....	27
6.6.5. Master/Slave Mode.....	28

- 6.6.6. Settings.....28
 - 6.6.6.1. Curves Select29
 - 6.6.6.2. Dimmer Speed29
 - 6.6.6.3. Pixel Invert30
 - 6.6.6.4. DMX Fail.....30
 - 6.6.6.5. DMX Sync30
 - 6.6.6.6. Lock.....31
 - 6.6.6.7. Factory31
- 6.6.7. Information.....31
- 6.7. DMX Channels32
 - 6.7.1. 4 Channels, 5 Channels, 6 Channels, 10 Channels32
 - 6.7.2. 8 Channels, 16 Channels, 19 Channels34
- 6.8. Supported RDM PIDs (Parameter IDs)35
- 7. Troubleshooting36**
- 8. Maintenance37**
 - 8.1. Safety Instructions for Maintenance37
 - 8.2. Preventive Maintenance37
 - 8.2.1. Basic Cleaning Instructions38
 - 8.3. Corrective Maintenance38
 - 8.3.1. Replacing the Fuse38
- 9. Deinstallation, Transportation and Storage39**
 - 9.1. Instructions for Deinstallation.....39
 - 9.2. Instructions for Transportation39
 - 9.3. Storage39
- 10. Disposal39**
- 11. Approval.....39**

1. Introduction

1.1. Before Using the Product

**Important**

Read and follow the instructions in this user manual before installing, operating or servicing this product.

The manufacturer will not accept liability for any resulting damages caused by the non-observance of this manual.

After unpacking, check the contents of the box. If any parts are missing or damaged, contact your Highlite International dealer.

Your shipment includes:

- Showtec Lightset PRO 9/10 RGBM
- 2 x safety eye
- 1 x spigot
- 2 x quick-lock bracket
- Schuko to pro power cable (5 m)
- User manual

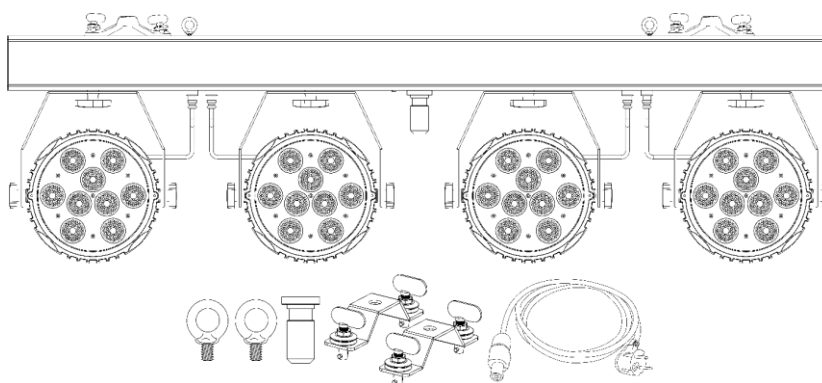
**Fig. 01**

1.2. Intended Use

This device is intended for professional use as a LED bar. It is suitable only for indoor installation. This device is not suitable for households and for general lighting.

Any other use, not mentioned under intended use, is regarded as non-intended and incorrect use.

1.3. Product Lifespan

This device is not designed for permanent operation. Disconnect the device from the electrical power supply when the device is not in operation. This will reduce the wear and will improve the device's lifespan.

1.4. LEDs Lifespan

The light output of the LEDs gradually decreases over time (lumen depreciation). High operating temperatures contribute to this process. You can extend the lifespan of the LEDs by providing adequate ventilation and operating the LEDs at the lowest possible brightness.

1.5. Text Conventions









Throughout the user manual the following text conventions are used:

- Buttons: All buttons are in bold lettering, for example "Press the **UP/DOWN** buttons"
- References: References to chapters and parts of the device are in bold lettering, for example: "Refer to **2. Safety**", "turn the **adjustment screw (02)**"
- 0–255: Defines a range of values
- Notes: **Note:** (in bold lettering) is followed by useful information or tips

1.6. Symbols and Signal Words

Safety notes and warnings are indicated throughout the user manual by safety signs.





Always follow the instructions provided in this user manual.

	DANGER	Indicates an imminently hazardous situation which, if not avoided, will result in death or serious injury.
	WARNING	Indicates a potentially hazardous situation which, if not avoided, could result in death or serious injury.
	CAUTION	Indicates a potentially hazardous situation, which, if not avoided, may result in minor or moderate injury.
	Attention	Indicates important information for the correct operation and use of the product.
	Important	Read and observe the instructions in this document.
	Electrical hazard	
	Hot surface	
	Eye damage hazard	
		Provides important information about the disposal of this product.

1.7. Symbols on the Information Label

This product is provided with an information label. The information label is located on the backside of the device.

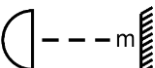
The information label contains the following symbols:

	This device is designed for indoor use.
	This device shall not be treated as household waste.
	This device falls under IEC protection class I.
	Minimum distance from lighted objects.
	Caution: Risk of electric shock. Disconnect input power before opening. This appliance must be earthed.

2. Safety



Important
Read and follow the instructions in this user manual before installing, operating or servicing this product.

The manufacturer will not accept liability for any resulting damages caused by the non-observance of this manual.

2.1. Warnings and Safety Instructions



DANGER
Danger for children

For adult use only. The device must be installed beyond the reach of children.

- Do not leave various parts of the packaging (plastic bags, polystyrene foam, nails, etc.) within children's reach. Packaging material is a potential source of danger for children.



DANGER
Electric shock caused by dangerous voltage inside

There are areas within the device where dangerous touch voltage (> 120 V DC) may be present.

- Do not open the device or remove any covers.
- Do not operate the device if the covers or the housing are open. Before operation, check if the housing is firmly closed and all screws are tightly fastened.
- Disconnect the device from electrical power supply before service and maintenance, and when the device is not in use.



DANGER
Electric shock caused by short-circuit

This device falls under IEC protection class I.

- Make sure that the device is electrically connected to ground (earth). Connect the device only to a socket-outlet with ground (earth) connection.
- Do not cover the ground (earth) connection.
- Do not bypass the thermostatic switch or fuses.
- For replacement use fuses of the same type and rating only.
- Do not let the power cable come into contact with other cables. Handle the power cable and all connections with the mains with caution.
- Do not modify, bend, mechanically strain, put pressure on, pull or heat up the power cable.
- Make sure that the power cable is not crimped or damaged. Examine the power cable periodically for any defects.
- Do not immerse the device in water or other liquids. Do not install the device in a location where flooding may occur.
- Do not use the device during thunderstorms. Disconnect the device from the electrical power supply immediately.



WARNING
Risk of burns due to hot surface

The surface and the inner parts of the device can become very hot during operation.

- Do not touch the device during operation.
- Allow the device to cool down for at least 15 minutes before handling.



WARNING
Risk of epileptic shock

Strobe lighting can trigger seizures in photosensitive epilepsy. Sensitive persons should avoid looking at strobe lights.



WARNING
Possible eye damage caused by high light intensity

Possibly hazardous optical radiation emitted from this device.

- Do not look at the operating light source. May be harmful to the eye.
- Do not look at the light source with optical instruments that may concentrate the light output.
- Make sure that persons are not looking directly into the light source when the device lights up suddenly. This can happen when the device is powered or when it receives DMX signal, or when certain menu items are selected.
- Disconnect power supply before servicing.
- Wear protective goggles if looking into light source during service or maintenance.



Attention
Power supply

- Before connecting the device to the power supply, make sure that the current, voltage and frequency match the input voltage, current and frequency specified on the information label on the device.
- Make sure that the cross-sectional area of the extension cords and power cables is sufficient for the required power consumption of the device.



Attention
General safety

- Do not insert objects into the air vents.
- Do not connect the device to a dimmer pack.
- Do not switch the device on and off in short intervals. This decreases the device's life.
- Do not shake the device. Avoid brute force when installing or operating the device.
- Change the lens or the LEDs if they are visibly damaged to such an extent that their effectiveness is impaired, for example by cracks or deep scratches. Contact your Highlite International dealer for more information, as servicing can be performed only by instructed or skilled persons.
- If the device is dropped or struck, disconnect the device from the electrical power supply immediately.

- If the device is exposed to extreme temperature variations (e.g. after transportation), do not switch it on immediately. Let the device reach room temperature before switching it on, otherwise it may be damaged by the formed condensation.
- If the device fails to work properly, discontinue the use immediately.



Attention
For professional use only
This device shall be used only for the purposes it is designed for.

This device is designed to be used as a professional stage light effect. Any incorrect use may lead to hazardous situations and result in injuries and material damage.

- This device is not suitable for households and for general lighting.
- This device is not designed for permanent operation.
- This device does not contain user-serviceable parts. Unauthorized modifications to the device will render the warranty void. Such modifications may result in injuries and material damage.



Attention
Before each use, examine the device visually for any defects.

Make sure that:

- All screws used for installing the device or parts of the device are tightly fastened and are not corroded.
- The safety devices are not damaged.
- There are no deformations on housings, fixations and installation points.
- The lens is not cracked or damaged.
- The power cables are not damaged and do not show any material fatigue.



Attention
Do not expose the device to conditions that exceed the rated IP class conditions.

This device is IP20 rated. IP (Ingress Protection) 20 class provides protection against solid objects greater than 12 mm, such as fingers, and no protection against harmful ingress of water.

2.2. Requirements for the User

This product may be used by ordinary persons. Maintenance may be carried by ordinary persons. Installation and service shall be carried out only by instructed or skilled persons. Contact your Highlite dealer for more information.

Instructed persons have been instructed and trained by a skilled person, or are supervised by a skilled person, for specific tasks and work activities associated with the installation, service and maintenance of this product, so that they can identify risks and take precautions to avoid them.

Skilled persons have training or experience, which enables them to recognize risks and to avoid hazards associated with the installation, service and maintenance of this product.

Ordinary persons are all persons other than instructed persons and skilled persons. Ordinary persons include not only users of the product but also any other persons that may have access to the device or who may be in the vicinity of the device.

3. Description of the Device

The Lightset PRO 9/10 RGBM is a high-level and rental-friendly T-bar with 4 spots, each equipped with 9 pieces of 10 W RGB and Mint LEDs. Thanks to the presence of the Mint LEDs, it is possible to create much better quality white and pastel colors. You can further enhance the performance by means of the optional 20° and 40° beamshapers.

The T-bar is lightweight and can be placed on a stand or be mounted to a truss with the included quick-lock brackets.

3.1. Front View

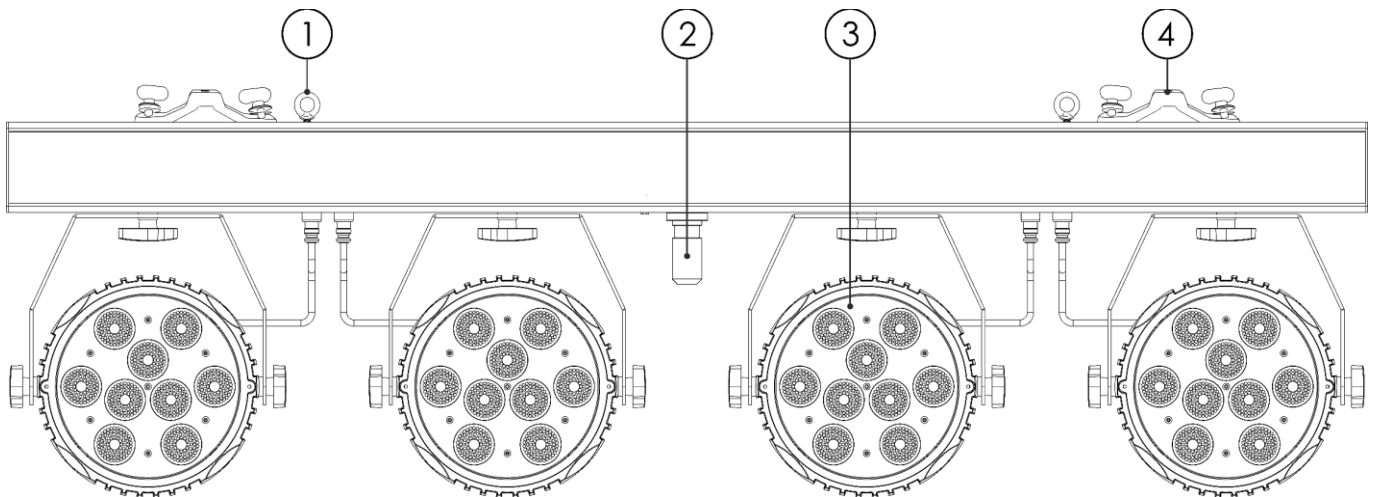
**Fig. 02**

- 01) Safety eye
- 02) 28-mm spigot
- 03) 4 x 9 RGBM LEDs (10 W)
- 04) Quick-lock bracket

3.2. Back View

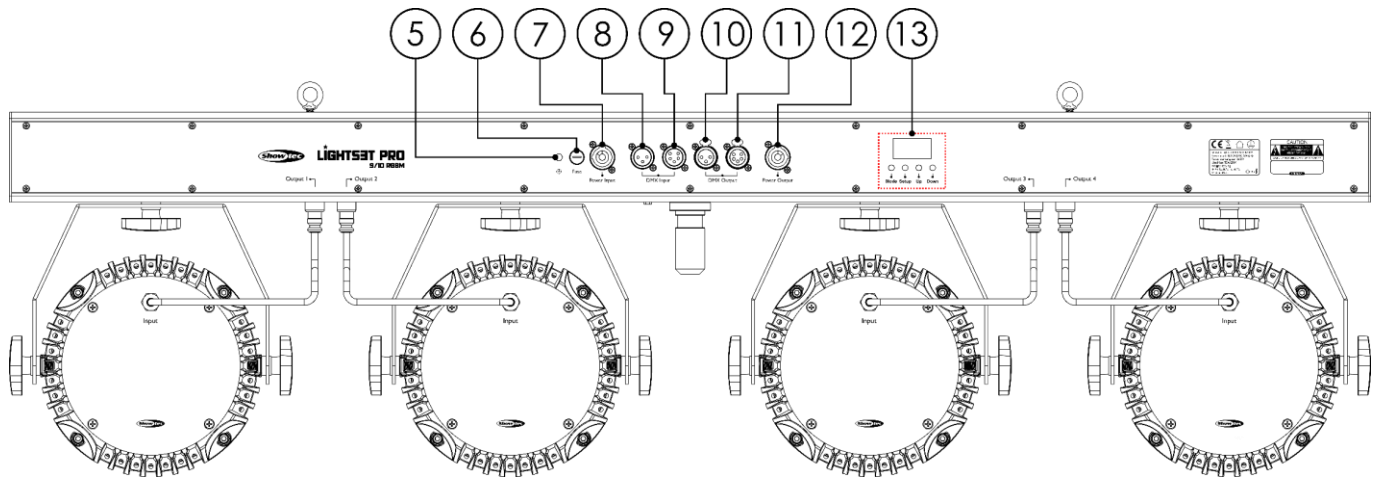

Fig. 03

- 05) Ground/earth connection
- 06) Fuse T5L/250 V
- 07) Pro power connector (Blue) IN
- 08) 3-pin DMX signal connector IN
- 09) 5-pin DMX signal connector IN
- 10) 3-pin DMX signal connector OUT
- 11) 5-pin DMX signal connector OUT
- 12) Pro power connector (Gray) OUT
- 13) Control panel: OLED display and control buttons

3.3. Side View

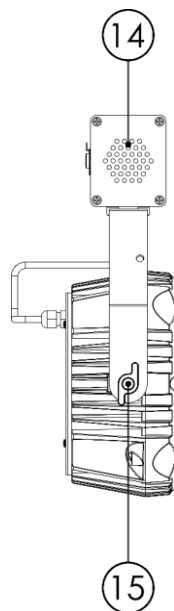

Fig. 04

- 14) Air vent
- 15) Adjustment screw

3.4. Product Specifications

Model:	Lightset PRO 9/10 RGBM
Electrical:	
Input voltage:	100–240 V AC, 50/60 Hz
Power consumption:	260 W
Fuse:	T5L/250 V
Physical:	
Dimensions:	1287 x 135 x 364 mm (LxWxH)
Weight:	13,2 kg
Optics:	
Light source:	4 x 9 RGBM LEDs (10 W)
Dimmer:	0–100 %
Strobe:	0–20 Hz
Beam angle:	8° (20° and 40° with the optional beam shapers)
Refresh rate:	>1000 Hz
Operation and control:	
Control:	Manual, Auto, Built-in programs, Master/Slave, DMX-512, RDM
DMX channels:	4, 5, 6, 8, 10, 16, 19 channels
Control panel:	OLED display and buttons
Connections:	
Power connections:	Pro power connectors (Blue) IN/(Gray) OUT
Data connections:	3-pin/5-pin DMX connectors IN/OUT
Signal pinouts:	3-pin: pin 1 (ground), pin 2 (-), pin 3 (+) 5-pin: pin 1 (ground), pin 2 (-), pin 3 (+), pin 4 (N/C), pin 5 (N/C)
Construction:	
Housing:	High-grade die-cast aluminum
Color:	Black
IP rating:	IP20
Thermal:	
Maximum ambient temperature t_a :	40 °C
Maximum housing temperature t_c :	60 °C
Minimum distance:	
Minimum distance from flammable surfaces:	0,5 m
Minimum distance to lighted object:	0,5 m

3.5. Optional Accessories

You can additionally purchase the following accessories:

Product code: [30291](#) (Beamshaper for Lightset PRO 9/10 RGBM 20°)

Product code: [30292](#) (Beamshaper for Lightset PRO 9/10 RGBM 40°)

Product code: [70912](#) (Lighting stand Alu, including spigot adapter)

3.6. Dimensions

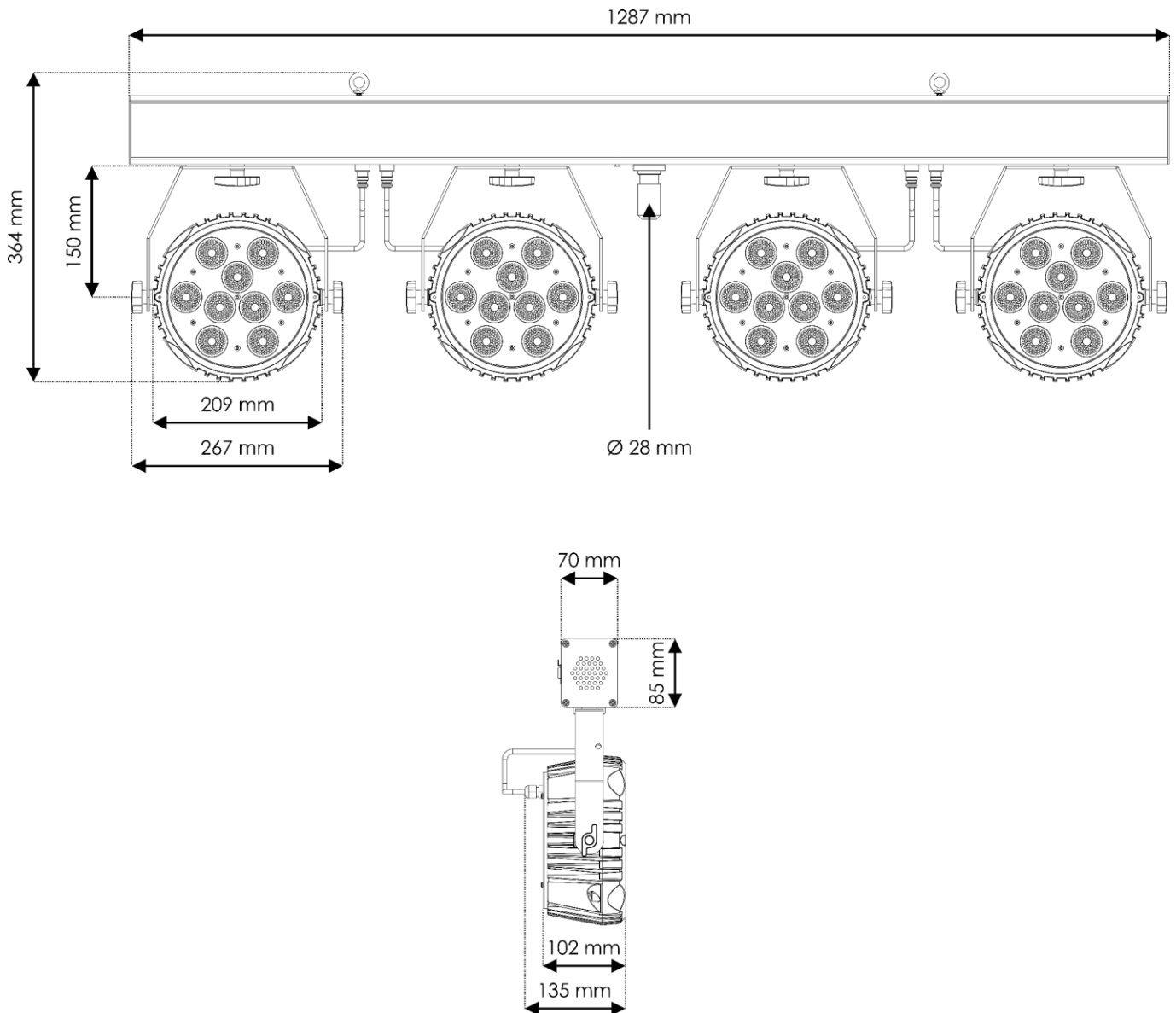

Fig. 05

4. Installation

4.1. Safety Instructions for Installation



WARNING

Incorrect installation can cause serious injuries and damage of property.

If trussing systems are used, installation must be carried out only by instructed or skilled persons.

Follow all applicable European, national and local safety regulations concerning rigging and trussing.

4.2. Personal Protective Equipment

During installation and rigging wear personal protective equipment in compliance with the national and site-specific regulations.

4.3. Installation Site Requirements

- The device can be used only indoors.
- The device can be mounted to a truss or other rigging structure in any orientation.
- The minimum distance to other objects must be bigger than 0,5 m.
- The minimum distance between the light output and the illuminated surface must be bigger than 0,5 m.
- The maximum ambient temperature $t_a = 40\text{ °C}$ must never be exceeded.
- The relative humidity must not exceed 50 % with an ambient temperature of 40 °C .

4.4. Rigging

The device can be positioned on a flat surface or mounted to a truss or other rigging structure in any orientation. Make sure that all loads are within the pre-determined limits of the supporting structure.



CAUTION

Restrict the access under the work area during rigging and/or derigging.

To mount the device, follow the steps below:

- 01) Use the included quick-lock brackets to attach the device to the supporting structure, as shown in Fig. 06. Make sure that the device cannot move freely. Optionally, you can install the device on a lighting stand, as shown in Fig. 07. The lighting stand can be purchased separately.
- 02) Secure the device with a secondary suspension, for example a safety cable. Make sure that the secondary suspension can hold 10 times the weight of the device. If possible, the secondary suspension should be attached to a supporting structure independent of the primary suspension. Put the safety cable through both **safety eyes (01)**, as shown in Fig. 06.

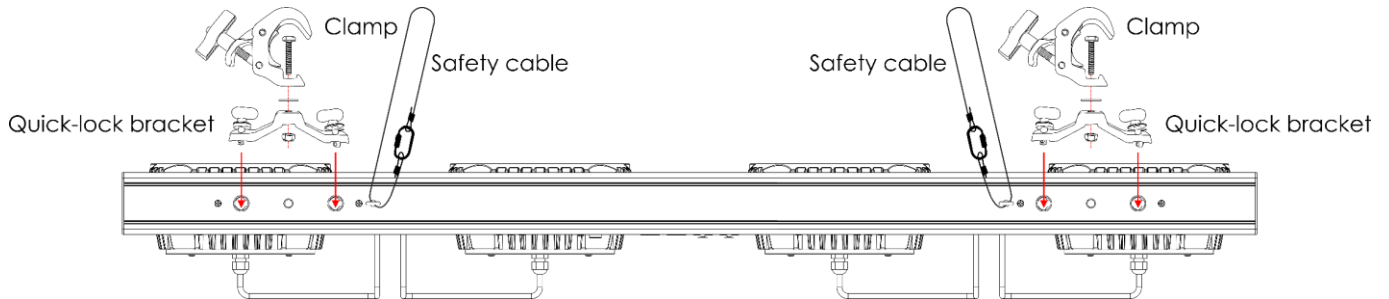

Fig. 06

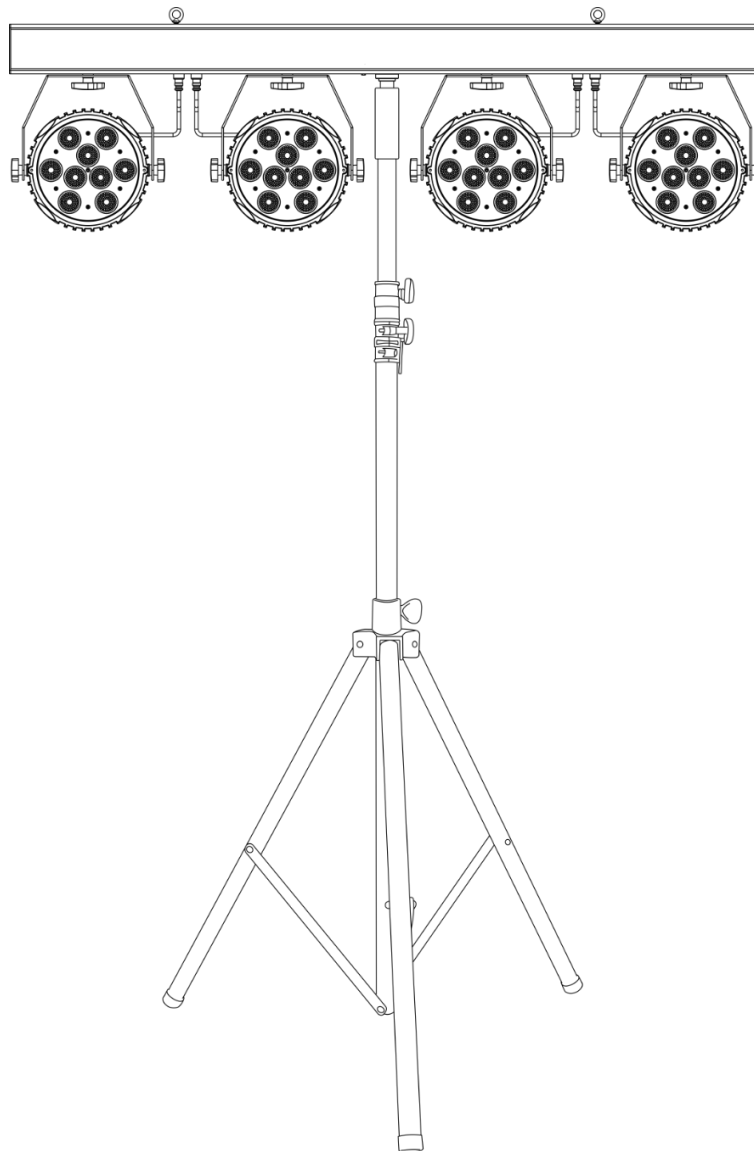

Fig. 07

4.4.1. Angle Adjustment

You can adjust the angle of the device with the **adjustment screws (15)**.

- 01) Turn the **adjustment screws (15)** counterclockwise to release them.
- 02) Tilt the device to the desired angle (see Fig. 08).
- 03) Turn the **adjustment screws (15)** clockwise to tighten them. Make sure that the device cannot move freely after the **adjustment screws (15)** are tightened.

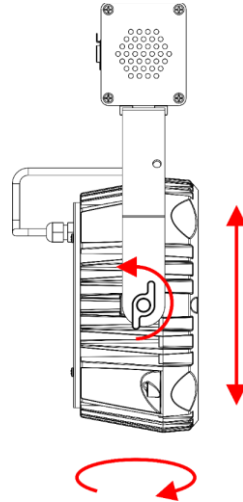

Fig. 08

4.5. Beamshaper Installation

You can use the optional beamshapers in order to change the beam angle of the device.

- 01) Place the beamshaper on the lens of the spot. The beamshaper is equipped with multiple magnets which keep it firmly in position.
- 02) In order to remove the beamshaper, pull it off holding it by the edge.
- 03) For extra safety, use a safety cable to connect the beamshaper to the spot.

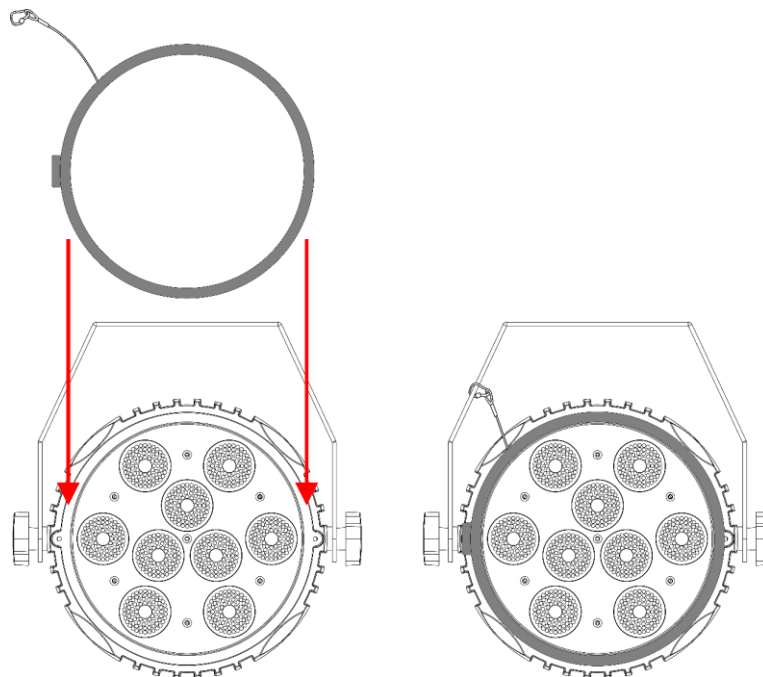

Fig. 09

4.6. Connecting to Power Supply



DANGER
Electric shock caused by short-circuit

The device accepts AC mains power at 100–240 V and 50/60 Hz. Do not supply power at any other voltage or frequency to the device.

This device falls under IEC protection class I. Make sure that the device is always electrically connected to the ground (earth).

Before connecting the device to the socket-outlet:

- Make sure that the power supply matches the input voltage specified on the information label on the device.
- Make sure that the socket-outlet has ground (earth) connection.

Connect the device to the socket-outlet with a power plug. Do not connect the device to a dimmer pack, as this may damage the device.

4.7. Power Linking of Multiple Devices

This device supports power linking. Power can be relayed to another device via the power OUT connector. Note that the input and the output connectors have different designs: one type cannot be connected to the other.

Power linking of multiple devices must be carried out only by instructed or skilled persons.



WARNING
Incorrect power linking may lead to overload of the electrical circuit and result in serious injuries and damage of property.

To prevent overload of the electrical circuit, when power linking multiple devices:

- Use cables with sufficient current-carrying capacity. The power cable supplied with the device is not suitable for power linking of multiple devices.
- Make sure that the total current draw of the device and all connected devices does not exceed the rated capacity of the power cables and the circuit breaker.
- Do not link more devices on one power link than the maximum recommended number.

Maximum recommended number of devices:

- at 100–120 V: 6 devices
- at 200–240 V: 12 devices

5. Setup

5.1. Warnings and Precautions

**Attention**

Connect all data cables before supplying power.

Disconnect power supply before connecting or disconnecting data cables.

5.2. Stand-alone Setup

When the Lightset PRO 9/10 RGBM is not connected to a controller or to other devices, it functions as a stand-alone device. It can be operated manually or in auto mode.

For more information about the control modes, refer to **6.2. Control Modes** on page 20.

5.3. DMX Connection

5.3.1. DMX-512 Protocol

You need a DMX serial data link to run light shows of one or more devices using a DMX-512 controller or to run synchronized shows of two or more devices set in a master/slave operating mode.

The Lightset PRO 9/10 RGBM has 3-pin/5-pin DMX signal IN and OUT connectors.

The pin assignment is as follows:

- 3-pin: pin 1 (ground), pin 2 (-), pin 3 (+)
- 5-pin: pin 1 (ground), pin 2 (-), pin 3 (+), pin 4 (N/C), pin 5 (N/C)

Devices on a serial data link must be daisy-chained in a single line. The number of devices that you can control on one data link is limited by the combined number of the DMX channels of the connected devices and the 512 channels available in one DMX universe.

To comply with the TIA-485 standard, no more than 32 devices should be connected on one data link. In order to connect more than 32 devices on one data link, you must use a DMX optically isolated splitter/booster, otherwise this may result in deterioration of the DMX signal.

Note:

- Maximum recommended DMX data link distance: 300 m
- Maximum recommended number of devices on a DMX data link: 32 devices

5.3.2. DMX Cables

Shielded twisted-pair cables with 5-pin XLR connectors must be used for reliable DMX connection. You can purchase DMX cables directly from your Highlite International dealer or make your own cables.

If you use 3-pin XLR audio cables for DMX data transmission, this may lead to signal degradation and unreliable operation of the DMX network.

When you make your own DMX cables, make sure that you connect the pins and wires correctly as shown in Fig. 10.

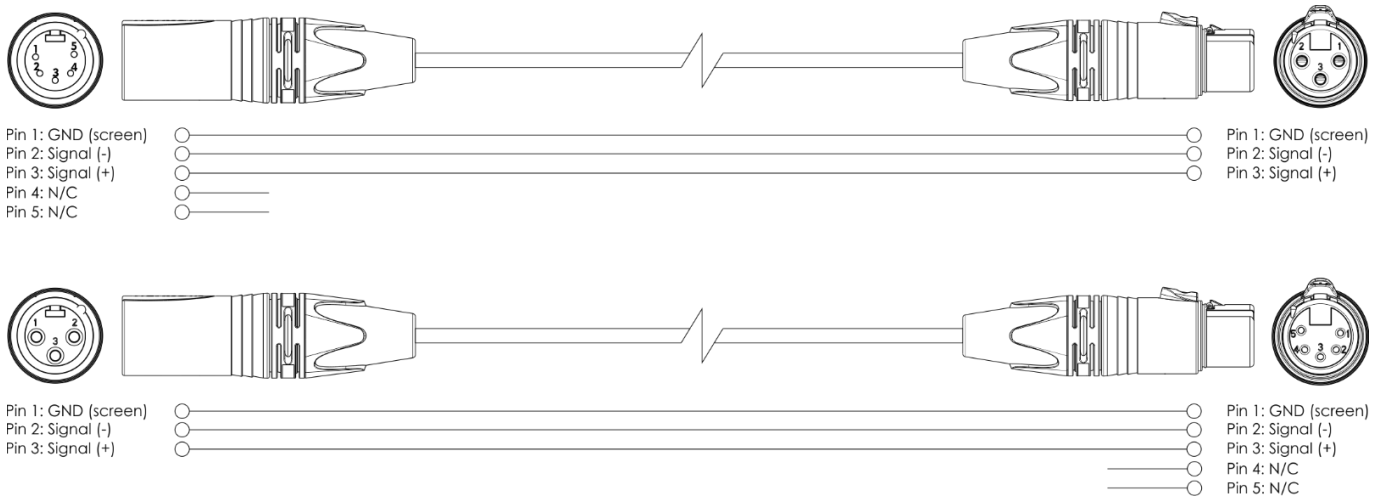

Fig. 10

5.3.3. Master/Slave Setup

The Lightset PRO 9/10 RGBM supports master/slave control mode. To connect multiple devices in master/slave setup, follow the steps below:

- 01) Connect the first device's DMX OUT connector to the second device's DMX IN connector.
- 02) Repeat step 1 to connect all devices as shown in Fig. 11.
- 03) Connect a DMX terminator (120 Ω resistor) to the DMX OUT connector of the last device in the setup.
- 04) Set the first device on the data link as a master device. See **6.6.5. Master/Slave Mode** on page 28 for more information.
- 05) Set the remaining devices to slave mode. See **6.6.5. Master/Slave Mode** on page 28 for more information.

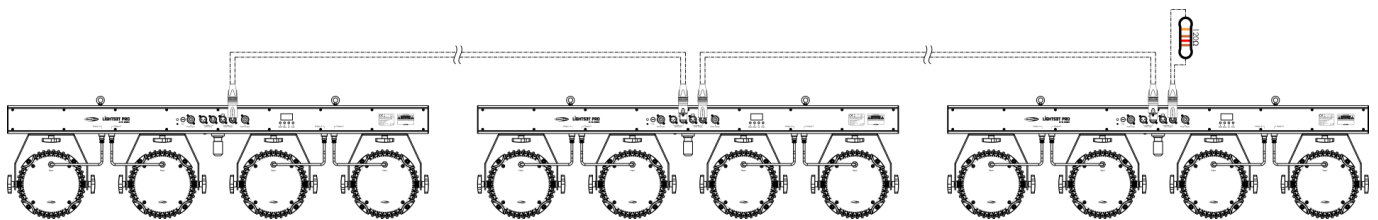

Fig. 11

5.3.4. DMX Linking

To connect multiple devices on one DMX data link, follow the steps below:

- 01) Use a 3-pin/5-pin DMX cable to connect the DMX OUT connector of the lighting controller to the DMX IN connector of the first device.
- 02) Connect the first device's DMX OUT connector to the second device's DMX IN connector with a 3-pin/5-pin DMX cable.
- 03) Repeat step 2 to connect all devices in a daisy-chain as shown in Fig. 12.
- 04) Connect a DMX terminator (120 Ω resistor) to the DMX OUT connector of the last device on the data link.

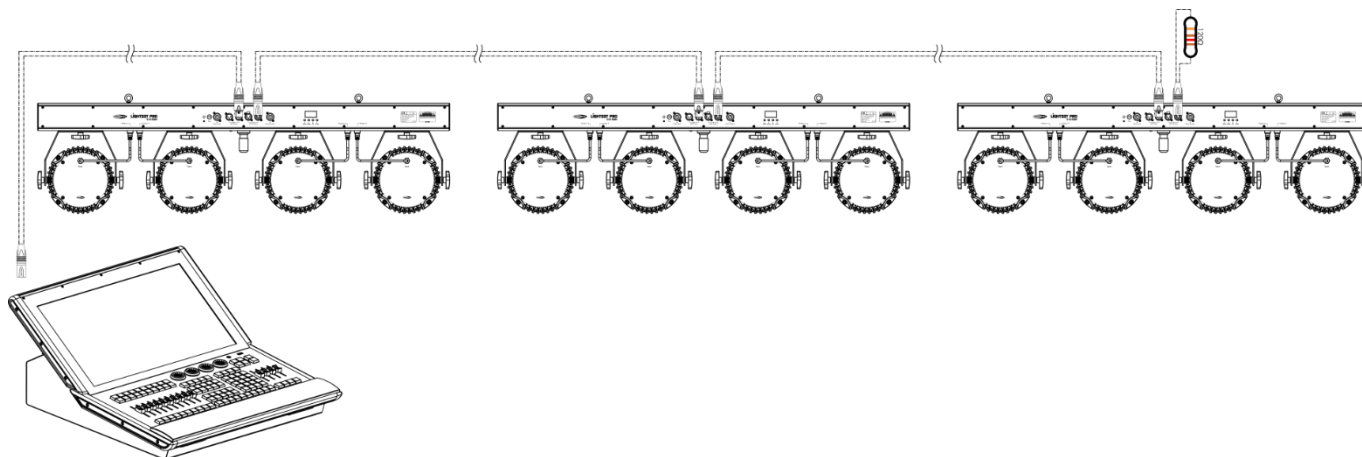

Fig. 12

5.3.5. DMX Addressing

In a setup with multiple devices, make sure that you set the DMX starting address of each device correctly. The Lightset PRO 9/10 RGBM has 7 personalities: 4 channels, 5 channels, 6 channels, 8 channels, 10 channels, 16 channels and 19 channels.

If you want to connect multiple devices on one data link and use them in 19-channel mode, for example, follow the steps below:

- 01) Set the starting address of the 1st device on the data link to 1 (001).
- 02) Set the starting address of the 2nd device on the data link to 20 (020), as $1 + 19 = 20$.
- 03) Set the starting address of the 3rd device on the data link to 21 (021) as $20 + 19 = 39$.
- 04) Continue assigning the starting addresses of the remaining devices by adding each time 10 to the previous number.

Make sure that you do not have any overlapping channels in order to control each Lightset PRO 9/10 RGBM correctly. If two or more devices are addressed similarly, they will work similarly.

6. Operation

6.1. Safety Instructions for Operation



Attention

This device must be used only for the purposes it is designed for.

This device is intended for professional use as a T-bar. It is suitable only for indoor installation. This device is not suitable for households and for general lighting.

Any other use, not mentioned under intended use, is regarded as non-intended and incorrect use.



Attention

Power supply

Before connecting the device to the power supply, make sure that the current, voltage and frequency match the input voltage, current and frequency specified on the information label on the device.

6.2. Control Modes

The Lightset PRO 9/10 RGBM supports the following control modes:

- Stand-alone: Manual, Auto, Built-in programs
- Master/Slave: Manual, Auto, Built-in programs
- DMX-512, RDM 4, 5, 6, 8, 10, 16, 19 channels

For more information about how to connect the devices, refer to **5. Setup** on pages 17–19.

To operate the device manually as a stand-alone device or in a master/slave setup:

- Adjust the colors in Manual menu. See **6.6.2.2. Color All** and **6.6.2.3. Color Pixel** on page 26 for more information.

To run the built-in programs without a DMX controller:

- 01) Select one of the 22 built-in programs in Program menu. See **6.6.4. Program** on page 27 for more information. Adjust the program speed and strobe frequency.
- 02) Run all built-in programs in a sequence in Auto menu. See **6.6.3. Auto** on page 27 for more information.

To run the preset colors without a DMX controller:

- 01) Select one of the 46 preset colors in Color Preset menu. See **6.6.2.1. Color Preset** on page 26 for more information.

To operate the device with a DMX controller:

- 01) Set the DMX starting address of the device in Address menu. See **5.3.5. DMX Addressing** on page 19 and **6.6.1.1. Address** on page 25.
- 02) Select the DMX channel mode. See **6.6.1.2. Channels** on page 25 for more information. See **6.7. DMX Channels** on pages 32–34 for complete overview of all DMX channels.

6.3. Control Panel

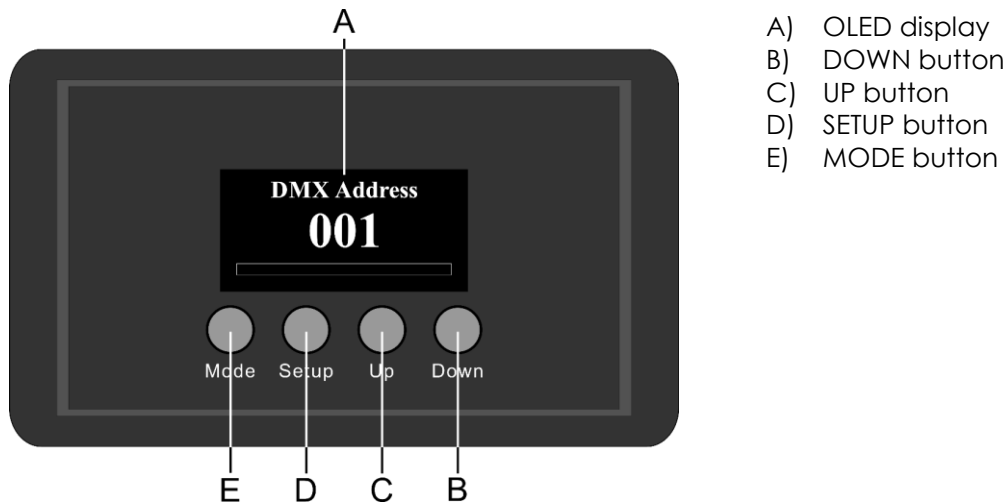

Fig. 13

- Use the **MODE** button to exit the current submenu and to return to the Main Menu.
- Use the **UP/DOWN** buttons to navigate through the menus or to increase/decrease numeric values.
- Use the **SETUP** button to open the desired menu, to confirm your choice or to set the currently selected value.

6.4. Start-up

Upon start-up the display will briefly show its software version and current temperature.

Note:

- If no button is pressed after 30 seconds of inactivity, the display will show the start screen. Press any button to return to the main menu.
- By default the display is locked. To access the main menu, you need to enter the **password**. Press and hold down the **MODE** and **SETUP** buttons for 3 seconds to unlock the display. See **6.6.6.6. Lock** on page 31 for more information.

6.5. Menu Overview

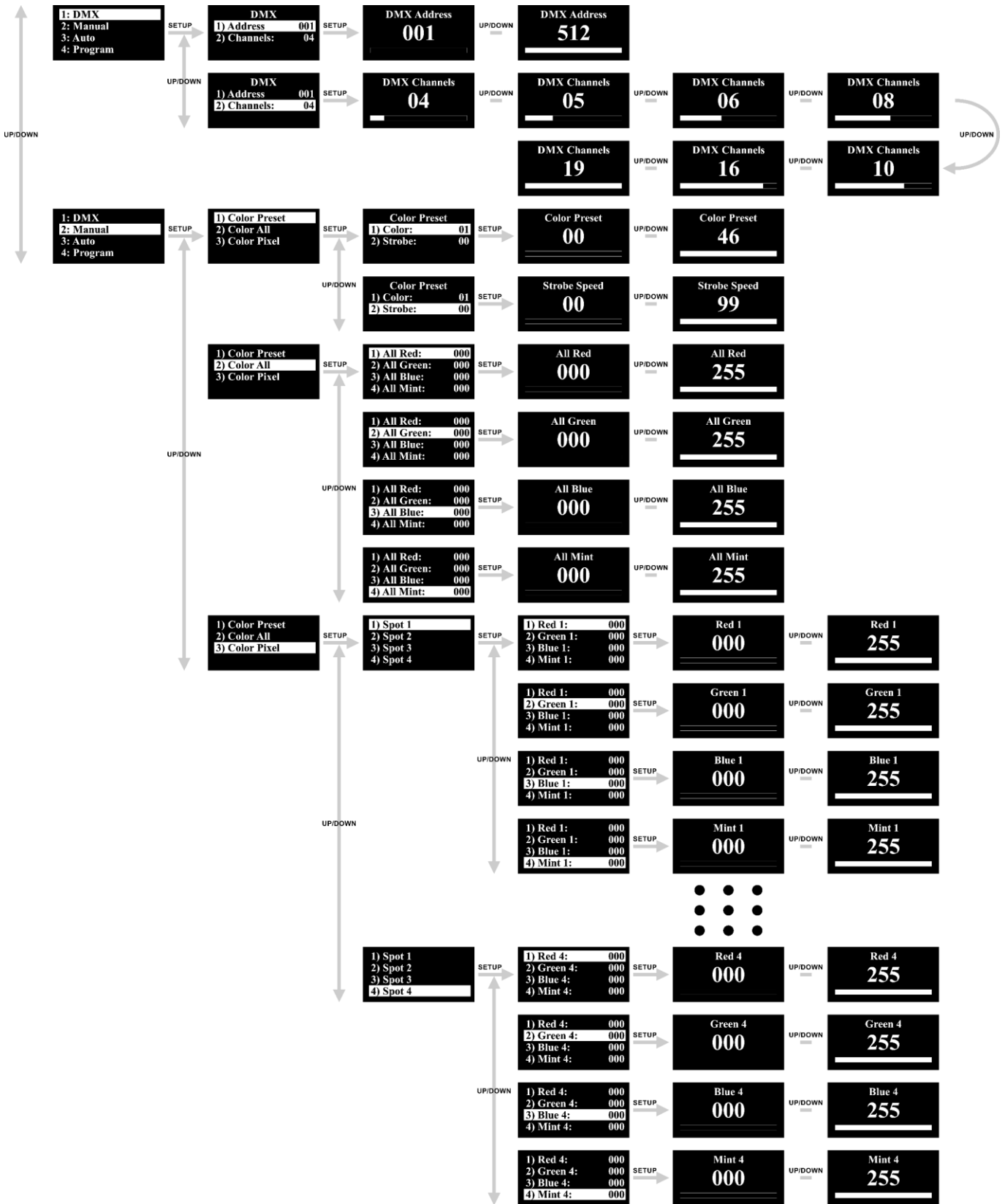

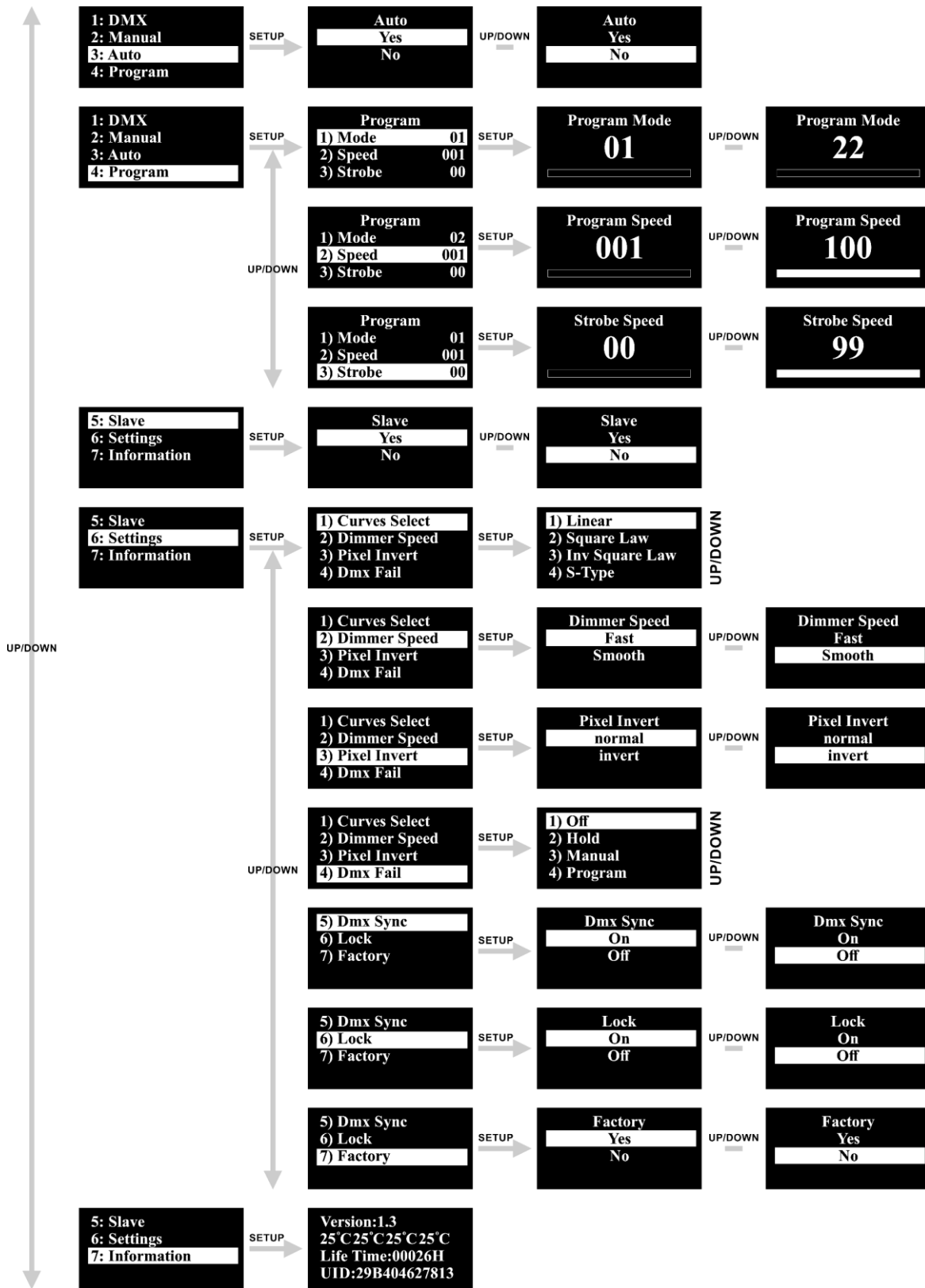

6.6. Main Menu Options

Upon start-up, the display will show the current software version and the temperature.

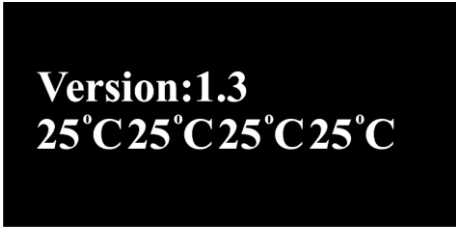

Version:1.3
25°C25°C25°C25°C

The main menu has the following options:

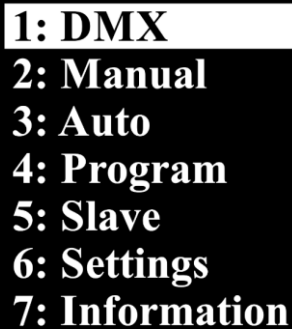

1: DMX
2: Manual
3: Auto
4: Program
5: Slave
6: Settings
7: Information

- 01) Press the **UP/DOWN** buttons to navigate through the main menu.
- 02) Press the **SETUP** button to open the submenus.

Note: By default the display is locked. To access the main menu, you need to enter the **password**. Press and hold down the **MODE** and **SETUP** buttons for 3 seconds to unlock the display. See **6.6.6.6 Lock** on page 31 for more information.

6.6.1. DMX Settings

In this menu you can set the DMX address and choose the desired DMX mode.

- 01) While in the main menu, press the **UP/DOWN** buttons to choose DMX.
- 02) Press the **SETUP** button to enter the menu. The display will show:



DMX
1) Address 001
2) Channels: 04

- 03) Press the **UP/DOWN** buttons to select one of the 2 submenus:
 - ADDRESS
 - CHANNELS
- 04) Press the **SETUP** button to open the desired submenu.

6.6.1.1. Address

In this menu you can set the desired DMX starting address.



- 01) Press the **UP/DOWN** buttons to set the desired DMX address. The adjustment range is 001–512.
- 02) Press the **SETUP** button to confirm your choice.

6.6.1.2. Channels

In this menu you can set the desired DMX channel mode.



- 01) Press the **UP/DOWN** buttons to set the desired DMX channel mode. Choose one of the 7 options:
 - 4 channels
 - 5 channels
 - 6 channels
 - 8 channels
 - 10 channels
 - 16 channels
 - 19 channels
- 02) Press the **SETUP** button to confirm your choice.

6.6.2. Manual Mode

In this menu you can manually set the desired colors and color presets.

- 01) While in the main menu, press the **UP/DOWN** buttons to choose MANUAL.
- 02) Press the **SETUP** button to enter the menu. The display will show:



- 03) Press the **UP/DOWN** buttons to choose one of the 3 submenus:
 - COLOR PRESET
 - COLOR ALL
 - COLOR PIXEL
- 04) Press the **SETUP** button to confirm your choice

6.6.2.1. Color Preset

In this menu you can set the color presets.

01) If you have chosen COLOR PRESET, the display will show:

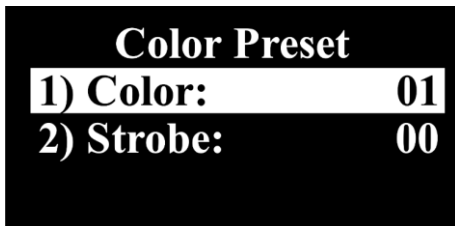

02) Press the **UP/DOWN** buttons to choose one of the 2 options:

- COLOR
- STROBE

03) Press the **SETUP** button to enter the desired menu.

04) If you have chosen COLOR, press the **UP/DOWN** buttons to choose one of the 46 color presets. Press the **SETUP** button to confirm your choice.

05) If you have chosen STROBE, press the **UP/DOWN** buttons to set the strobe frequency. The adjustment range is 0–99, from OFF to high frequency. Press the **SETUP** button to save your settings.

6.6.2.2. Color All

In this menu you can set the desired color on all 4 spots.

01) While in the main menu, press the **UP/DOWN** buttons to choose COLOR ALL.

02) Press the **SETUP** button to enter the menu. The display will show:



03) Press the **UP/DOWN** buttons to choose one of the 4 colors: All Red, All Green, All Blue and All Mint.

04) Press the **SETUP** button to enter the menu.

05) Press the **UP/DOWN** buttons to set the LED brightness. The adjustment range for each color is 0–255, from dark to brightest.

06) Press the **SETUP** button to save your settings.

07) You can combine Red, Green, Blue and Mint to create an infinite range of colors (0–255).

6.6.2.3. Color Pixel

In this menu you can set the desired color on each of the 4 spots, separately.

01) While in the main menu, press the **UP/DOWN** buttons to choose COLOR PIXEL.

02) Press the **SETUP** button to enter the menu. The display will show:

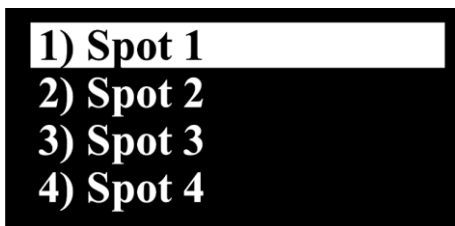

03) Press the **UP/DOWN** buttons to choose one of the 4 spots.

04) Press the **SETUP** button to confirm your choice.

05) The display will show:

1) Red 1:	000
2) Green 1:	000
3) Blue 1:	000
4) Mint 1:	000

- 06) Press the **UP/DOWN** buttons to choose one of the 4 colors: Red, Green, Blue and Mint.
 07) Press the **SETUP** button to enter the menu.
 08) Press the **UP/DOWN** buttons to set the LED brightness. The adjustment range for each color is 0–255, from dark to brightest.
 09) Press the **SETUP** button to save your settings.
 10) You can combine Red, Green, Blue and Mint to create an infinite range of colors (0–255).

6.6.3. Auto

In this menu you can set Auto mode.

- 01) While in the main menu, press the **UP/DOWN** buttons to choose AUTO.
 02) Press the **SETUP** button to enter the menu. The display will show:

Auto	
Yes	
No	

- 03) Press the **UP/DOWN** buttons to choose YES (to start the auto show) or NO (to return to the previous screen).
 04) Press the **SETUP** button to confirm your choice.

6.6.4. Program

In this menu you can set the built-in programs.

- 01) While in the main menu, press the **UP/DOWN** buttons to choose PROGRAM.
 02) Press the **SETUP** button to enter the menu. The display will show:

Program	
1) Mode	01
2) Speed	001
3) Strobe	00

- 03) Press the **UP/DOWN** buttons to choose one of the 3 options:
- MODE
 - SPEED
 - STROBE
- 04) Press the **SETUP** button to enter the desired menu.
 05) If you have chosen MODE, press the **UP/DOWN** buttons to choose one of the 22 built-in programs. Press the **SETUP** button to confirm your choice.
 06) If you have chosen SPEED, press the **UP/DOWN** buttons to set the built-in program's speed. The adjustment range is 1–100, from slow to fast. Press the **SETUP** button to save your settings.
 07) If you have chosen STROBE, press the **UP/DOWN** buttons to set the strobe frequency. The adjustment range is 0–99, from OFF to high frequency. Press the **SETUP** button to save your settings.

6.6.5. Master/Slave Mode

In this menu you can set the device as a slave.

- 01) While in the main menu, press the **UP/DOWN** buttons to choose SLAVE.
- 02) Press the **SETUP** button to enter the menu. The display will show:



- 03) Press the **UP/DOWN** buttons to choose YES or NO.
- 04) Press the **SET** button to confirm your choice.
- 05) If you have chosen YES, the device will be set as a slave and will react the same as the master device.

6.6.6. Settings

In this menu you can adjust the device's settings.

- 01) While in the main menu, press the **UP/DOWN** buttons to choose SETTINGS.
- 02) Press the **SETUP** button to enter the menu. The display will show:

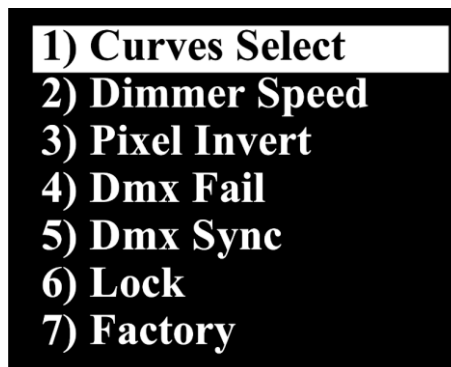

- 03) Press the **UP/DOWN** buttons to choose one of the 7 submenus:
 - CURVES SELECT
 - DIMMER SPEED
 - PIXEL INVERT
 - DMX FAIL
 - DMX SYNC
 - LOCK
 - FACTORY
- 04) Press the **SETUP** button to enter the desired submenu.

6.6.6.1. Curves Select

In this menu you can set the dimming curves.

- 1) Linear
- 2) Square Law
- 3) Inv Square Law
- 4) S-Type

- 01) Press the **UP/DOWN** buttons to choose one of the 4 dimming curves.
- 02) Press the **SETUP** button to confirm your choice.

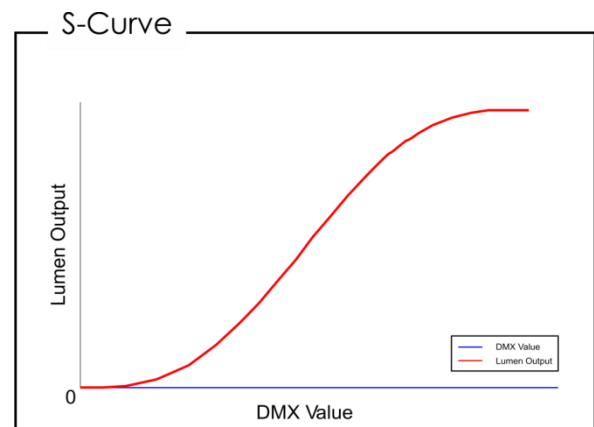
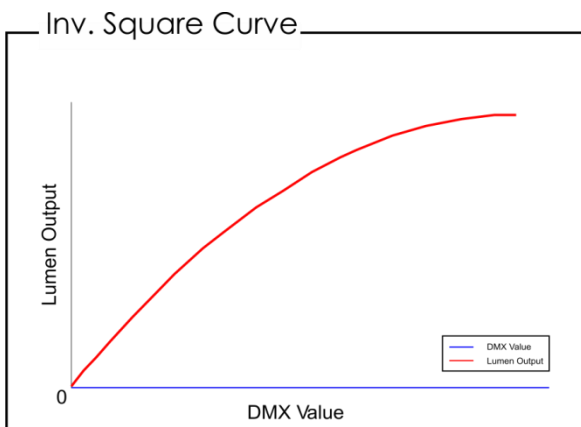
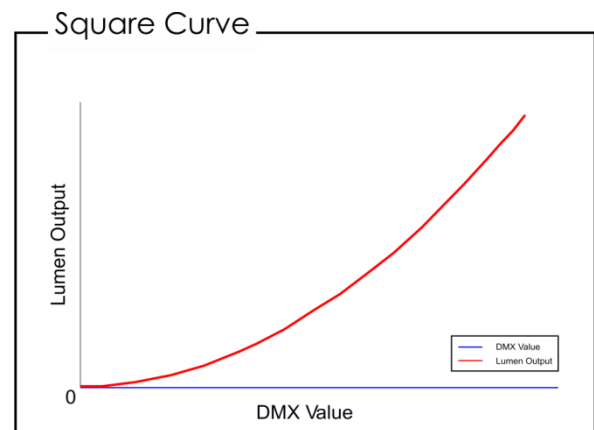
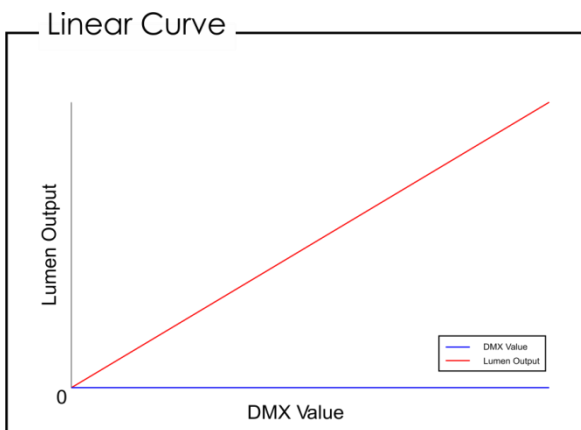

6.6.6.2. Dimmer Speed

In this menu you can set the dimmer speed.

- Dimmer Speed
- Fast
- Smooth

- 01) Press the **UP/DOWN** buttons to select FAST or SMOOTH.
- 02) Press the **SETUP** button to confirm your choice.

6.6.6.3. Pixel Invert

In this menu you can set the pixel direction.

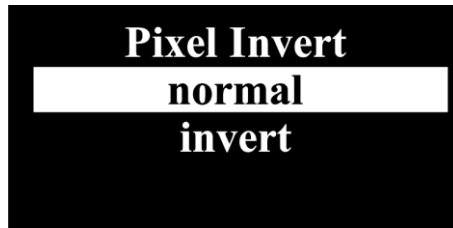

- 01) Press the **UP/DOWN** buttons to select NORMAL or INVERT.
- 02) Press the **SETUP** button to confirm your choice.

6.6.6.4. DMX Fail

In this menu you can set the device's behavior in case of a DMX failure.

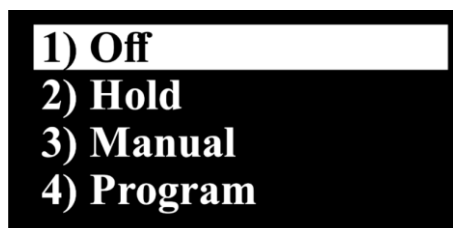

- 01) Press the **UP/DOWN** buttons to select one of the 4 options:
 - OFF: the device will black out the light output
 - HOLD: the device will use last properly received DMX signal, ensuring uninterrupted performance
 - MANUAL: the device will switch to Manual mode
 - PROGRAM: the device will run the built-in programs
- 02) Press the **SETUP** button to confirm your choice.

6.6.6.5. DMX Sync

In this menu you can set the devices' behavior, while using multiple Lightsets PRO.



- 01) Press the **UP/DOWN** buttons to select ON (all Lightset PROs will simultaneously perform the same action, without any delays) or OFF (risk of random delays).
- 02) Press the **SETUP** button to confirm your choice.

6.6.6.6. Lock

In this menu you can set the safety lock, restricting access to the main menu.



- 01) Press the **UP/DOWN** buttons to select one of the 2 options:
 - ON: when no button is pressed within 30 seconds, the device's main menu will be locked.
In order to unlock it, press and hold down the MODE and SETUP buttons for 3 seconds.
 - OFF: safety lock is inactive
- 02) Press the **SETUP** button to confirm your choice.

6.6.6.7. Factory

In this menu you can restore the default factory settings.



- 01) Press the **UP/DOWN** buttons to select YES or NO.
- 02) Press the **SETUP** button to confirm your choice.

6.6.7. Information

In this menu you can view the device's current software version, temperature, total lifetime and the device's UID number.

- 01) While in the main menu, press the **UP/DOWN** buttons to choose INFORMATION.
- 02) Press the **SETUP** button to enter the menu. The display will show:

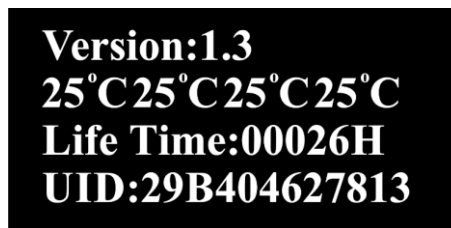

6.7. DMX Channels

6.7.1. 4 Channels, 5 Channels, 6 Channels, 10 Channels

4 CH	5 CH	6 CH	10 CH	Function	Value	Setting
	1	1	1	Master Dimmer	000–255	From low to high intensity (0–100 %)
	2	2	2	Linear Strobe	000–010	No function
					011–255	From low to high frequency (0–20 Hz)
			3	FX Strobe	000–010	No function
					011–255	From low to high frequency (0–20 Hz)
1		3		Red All	000–255	From low to high intensity (0–100 %)
2		4		Green All	000–255	From low to high intensity (0–100 %)
3		5		Blue All	000–255	From low to high intensity (0–100 %)
4		6		Mint All	000–255	From low to high intensity (0–100 %)
					000–007	No function
					005–009	Color 1 R 255; G 000; B 000; M 000
					010–014	Color 2 R 255; G 000; B 100; M 000
					015–019	Color 3 R 075; G 000; B 255; M 000
					020–024	Color 4 R 000; G 000; B 255; M 000
					025–029	Color 5 R 000; G 225; B 255; M 000
					030–034	Color 6 R 000; G 255; B 125; M 000
					035–039	Color 7 R 200; G 255; B 000; M 000
					040–044	Color 8 R 255; G 200; B 075; M 000
					045–049	Color 9 R 255; G 050; B 000; M 000
					050–054	Color 10 R 255; G 000; B 150; M 000
					055–059	Color 11 R 125; G 000; B 255; M 000
					060–064	Color 12 R 000; G 075; B 255; M 000
					065–069	Color 13 R 000; G 255; B 255; M 000
					070–074	Color 14 R 000; G 255; B 050; M 000
					075–079	Color 15 R 255; G 255; B 000; M 000
					080–084	Color 16 R 100; G 200; B 255; M 000
					085–089	Color 17 R 255; G 125; B 000; M 000
					090–094	Color 18 R 255; G 000; B 200; M 000
					095–099	Color 19 R 175; G 000; B 255; M 000
	3		4	Color Presets	100–104	Color 20 R 000; G 125; B 255; M 000
					105–109	Color 21 R 000; G 255; B 225; M 000
					110–114	Color 22 R 000; G 255; B 000; M 000
					115–119	Color 23 R 255; G 225; B 000; M 000
					120–124	Color 24 R 175; G 255; B 255; M 000
					125–129	Color 25 R 255; G 175; B 000; M 000
					130–134	Color 26 R 255; G 000; B 255; M 000
					135–139	Color 27 R 225; G 000; B 255; M 000
					140–144	Color 28 R 000; G 175; B 255; M 000
					145–149	Color 29 R 000; G 255; B 175; M 000
					150–154	Color 30 R 150; G 255; B 000; M 000
					155–159	Color 31 R 255; G 200; B 025; M 000
					160–164	Color 32 R 255; G 255; B 255; M 000
					165–169	Color 33 R 255; G 175; B 075; M 000
					170–174	Color 34 R 255; G 150; B 255; M 000
					175–179	Color 35 R 255; G 100; B 255; M 000
					180–184	Color 36 R 125; G 225; B 255; M 000
					185–189	Color 37 R 175; G 255; B 150; M 000
					190–194	Color 38 R 150; G 255; B 075; M 000
					195–199	Color 39 R 000; G 000; B 000; M 255
					200–204	Color 40 R 255; G 200; B 050; M 000

4 CH	5 CH	6 CH	10 CH	Function	Value	Setting
					205–209	Color 41 R 175; G 028; B 000; M 255
					210–214	Color 42 R 175; G 080; B 035; M 255
					215–219	Color 43 R 160; G 115; B 060; M 255
					220–224	Color 44 R 140; G 100; B 150; M 255
					225–229	Color 45 R 125; G 150; B 115; M 255
					230–255	Color 46 R 125; G 150; B 140; M 255
	4		5	Built-in programs	000–010	No function
		011–021			Program 1	
		022–032			Program 2	
		033–043			Program 3	
		044–054			Program 4	
		055–065			Program 5	
		066–076			Program 6	
		077–087			Program 7	
		088–098			Program 8	
		099–109			Program 9	
		110–120			Program 10	
		121–131			Program 11	
		132–142			Program 12	
		143–153			Program 13	
		154–164			Program 14	
		165–175			Program 15	
		176–186			Program 16	
		187–197			Program 17	
		198–208			Program 18	
		209–219			Program 19	
		220–230			Program 20	
		231–241			Program 21	
	242–255	Program 22				
	5		6	Program speed	000–255	Speed adjustment, from slow to fast
			7	Red All	000–255	From low to high intensity (0–100 %)
			8	Green All	000–255	From low to high intensity (0–100 %)
			9	Blue All	000–255	From low to high intensity (0–100 %)
			10	Mint All	000–255	From low to high intensity (0–100 %)

Note: Make sure that the Master Dimmer channel is open in order to see the light output.

6.7.2. 8 Channels, 16 Channels, 19 Channels

8 CH	16 CH	19 CH	Function	Value	Setting
		1	Master Dimmer	000–255	From low to high intensity (0–100 %)
		2	Linear Strobe	000–010	No function
				011–255	From low to high frequency (0–20 Hz)
		3	FX Strobe	000–010	No function
				011–255	From low to high frequency (0–20 Hz)
1	1	4	Red 1	000–255	From low to high intensity (0–100 %)
2	2	5	Green 1	000–255	From low to high intensity (0–100 %)
3	3	6	Blue 1	000–255	From low to high intensity (0–100 %)
4	4	7	Mint 1	000–255	From low to high intensity (0–100 %)
1	5	8	Red 2	000–255	From low to high intensity (0–100 %)
2	6	9	Green 2	000–255	From low to high intensity (0–100 %)
3	7	10	Blue 2	000–255	From low to high intensity (0–100 %)
4	8	11	Mint 2	000–255	From low to high intensity (0–100 %)
5	9	12	Red 3	000–255	From low to high intensity (0–100 %)
6	10	13	Green 3	000–255	From low to high intensity (0–100 %)
7	11	14	Blue 3	000–255	From low to high intensity (0–100 %)
8	12	15	Mint 3	000–255	From low to high intensity (0–100 %)
5	13	16	Red 4	000–255	From low to high intensity (0–100 %)
6	14	17	Green 4	000–255	From low to high intensity (0–100 %)
7	15	18	Blue 4	000–255	From low to high intensity (0–100 %)
8	16	19	Mint 4	000–255	From low to high intensity (0–100 %)

Note: Make sure that the Master Dimmer channel is open in order to see the light output.

6.8. Supported RDM PIDs (Parameter IDs)

Parameter ID	Discovery command	SET command	GET command
DISC_UNIQUE_BRANCH	*		
DISC_MUTE	*		
DISC_UN_MUTE	*		
DEVICE_INFO			*
SOFTWARE_VERSION_LABEL			*
DMX_START_ADDRESS		*	*
IDENTIFY_DEVICE		*	*
SUPPORTED_PARAMETERS			*
SENSOR_DEFINITION			*
SENSOR_VALUE			*
DMX_PERSONALITY		*	*
DMX_PERSONALITY_DESCRIPTION			*
RESET_DEVICE		*	
FACTORY_DEFAULTS		*	

7. Troubleshooting

This troubleshooting guide contains solutions to problems which can be carried out by an ordinary person. The device does not contain user-serviceable parts.

Unauthorized modifications to the device will render the warranty void. Such modifications may result in injuries and material damage.

Refer servicing to instructed or skilled persons. Contact your Highlite International dealer in case the solution is not described in the table.

Problem	Probable cause(s)	Solution
The device does not function at all	No power to the device	<ul style="list-style-type: none"> Check if power is switched on and cables are plugged in
	Main fuse is blown	<ul style="list-style-type: none"> Replace the fuse. See 8.3.1. Replacing the Fuse on page 38
The device responds erratically	The factory settings of the device are changed	<ul style="list-style-type: none"> Reset the device's parameters to the default factory settings. See 6.6.6.7. Factory on page 31
The device does not respond to DMX control	The controller is not connected	<ul style="list-style-type: none"> Connect the controller
	The signal is reversed. The 3-pin/5-pin DMX OUT of the controller does not match the DMX IN of the device	<ul style="list-style-type: none"> Install a phase-reversing cable between the controller and the device
	The controller is defective	<ul style="list-style-type: none"> Try using another controller
The device responds erratically to DMX control	Bad data link connection	<ul style="list-style-type: none"> Examine connections and cables. Correct poor connections. Repair or replace damaged cables
	The data link is not terminated with a 120 Ω termination plug	<ul style="list-style-type: none"> Insert a termination plug in the DMX OUT connector of the last device on the link
	Incorrect addressing	<ul style="list-style-type: none"> Check address settings and correct, if necessary
	In case of a setup with multiple devices, one of the devices is defective and disturbs data transmission on the link	<ul style="list-style-type: none"> To find out the defective device, bypass one device at a time until normal operation is restored
No light or LEDs cut out intermittently	LEDs are damaged	<ul style="list-style-type: none"> Disconnect the device and contact your Highlite International dealer
	The power supply settings do not match local AC voltage and frequency	<ul style="list-style-type: none"> Disconnect the device. Check the settings and correct, if necessary

8. Maintenance

8.1. Safety Instructions for Maintenance



DANGER
Electric shock caused by dangerous voltage inside

Disconnect power supply before servicing or cleaning.



WARNING
Risk of burns due to hot surface

Allow the device to cool down for at least 15 minutes before servicing or cleaning.

8.2. Preventive Maintenance



Attention
Before each use, examine the device visually for any defects.

Make sure that:

- All screws used for installing the device or parts of the device are tightly fastened and are not corroded.
- The safety devices are not damaged.
- There are no deformations on housings, fixations and installation points.
- The lens is not cracked or damaged.
- The power cables are not damaged and do not show any material fatigue.

8.2.1. Basic Cleaning Instructions

The external lens of the device must be cleaned periodically in order to optimize the light output. The cleaning schedule depends on the conditions at the site where the device is installed. When smoke or fog machines are used at the site, the device will need more frequent cleaning. On the other hand, if the device is installed in well-ventilated area, it will need less frequent cleaning. To establish a cleaning schedule, examine the device at regular intervals during the first 100 hours of operation.

To clean the device, follow the steps below:

- 01) Disconnect the device from the electrical power supply.
- 02) Allow the device to cool down for at least 15 minutes.
- 03) Remove the dust collected on the external surface with dry compressed air and a soft brush.
- 04) Clean the lens with a damp cloth. Use a mild detergent solution.
- 05) Dry the lens carefully with a lint-free cloth.
- 06) Clean the DMX and other connections with a damp cloth.



Attention

- Do not immerse the device in liquid.
- Do not use alcohol or solvents.
- Make sure that the connections are fully dry before connecting the device to the power supply and to other devices.

8.3. Corrective Maintenance

The device does not contain user-serviceable parts. Do not open the device and do not modify the device.

Refer repairs and servicing to instructed or skilled persons. Contact your Highlite International dealer for more information.

8.3.1. Replacing the Fuse



DANGER Electric shock caused by short-circuit

- Do not bypass the thermostatic switch or fuses.
- For replacement use fuses of the same type and rating only.

Power surges, short-circuit or incorrect electrical power supply may cause a fuse to burn out. If the fuse burns out, the device will not function anymore. If this happens, follow the steps below.

- 01) Disconnect the device from the electrical power supply.
- 02) Allow the device to cool down for at least 15 minutes.
- 03) Loosen the fuse cover with a screwdriver and remove the fuse holder.
- 04) If the fuse is brown or unclear, it is burned out. Remove the old fuse.
- 05) Insert a new fuse in the fuse holder. Make sure that the type and the rating of the replacement fuse are the same as the ones specified on the information label of the product.
- 06) Replace the fuse holder in the opening and tighten the fuse cover.

9. Deinstallation, Transportation and Storage

9.1. Instructions for Deinstallation



WARNING

Incorrect deinstallation can cause serious injuries and damage of property.

- Let the device cool down before dismounting.
- Disconnect power supply before deinstallation.
- Always observe the national and site-specific regulations during deinstallation and derigging of the device.
- Wear personal protective equipment in compliance with the national and site-specific regulations.

9.2. Instructions for Transportation

- Use the original packaging to transport the device, if possible.
- Always observe the handling instructions printed on the outer carton box, for example: "Handle with care", "This side up", "Fragile".

9.3. Storage

- Clean the device before storing. Follow the cleaning instructions in chapter **8.2.1. Basic Cleaning Instructions** on page 38.
- Store the device in the original packaging, if possible.

10. Disposal

Correct disposal of this product

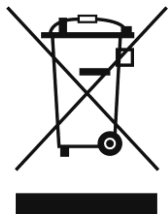

Waste Electrical and Electronic Equipment

This symbol on the product, its packaging or documents indicates that the product shall not be treated as household waste. Dispose of this product by handing it to the respective collection point for recycling of electrical and electronic equipment. This is to avoid environmental damage or personal injury due to uncontrolled waste disposal. For more detailed information about recycling of this product contact the local authorities or the authorized dealer.

11. Approval



Check the respective product page on the website of Highlite International (www.highlite.com) for an available declaration of conformity.



©2020 Showtec