

Lupo

Made in Italy

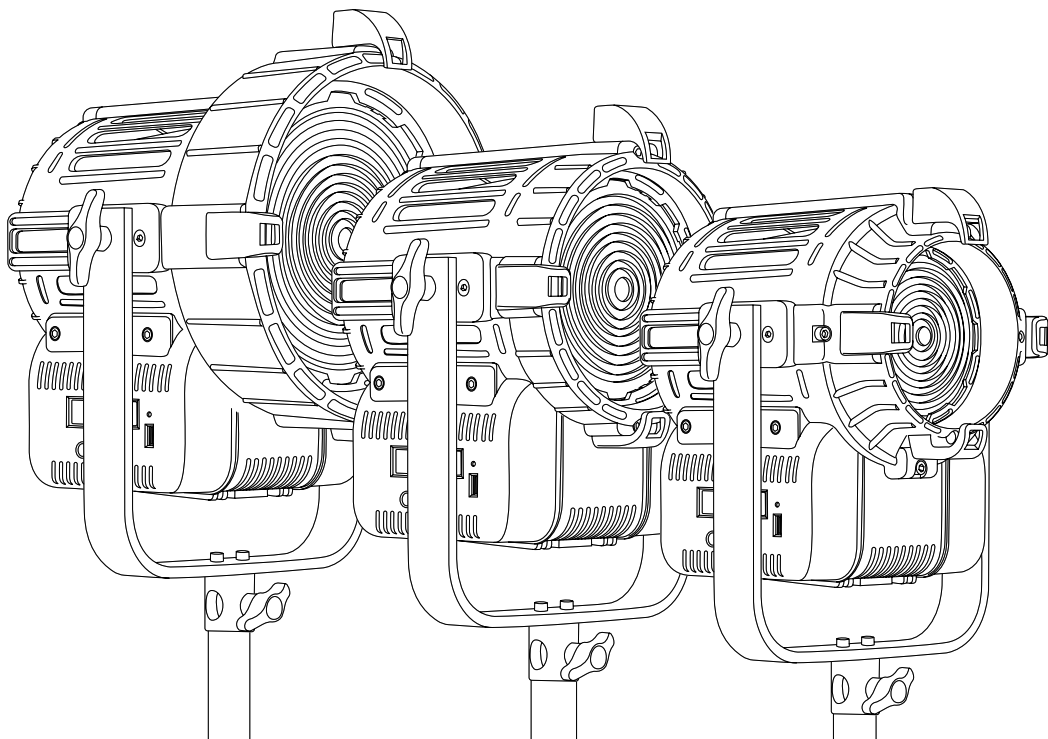

Dayled PRO

User Manual

DAYLED 650 PRO / DAYLED 650 PRO DUAL COLOR
DAYLED 1000 PRO / DAYLED 1000 PRO DUAL COLOR
DAYLED 2000 PRO / DAYLED 2000 PRO DUAL COLOR

Release 5.xx

SAFETY PRECAUTIONS:

Do not operate the equipment before studying the instruction manual and the accompanying safety precautions. Make sure that Lupo Safety Instruction is always included with the equipment! Lupo products are intended for professional use. Do not place or use the equipment where it can be exposed to moisture, extreme electromagnetic fields or in areas with flammable gases or dust! Do not expose the equipment to dripping or splashing. Do not place any objects filled with liquids on or near the equipment. Do not expose the equipment to hasty temperature changes in humid conditions as this could lead to condensation water in the unit. Equipment must only be serviced, modified or repaired by authorized and competent service personnel!

CAUTION - BURN HAZARD - HOT PARTS

Do not touch hot parts with bare fingers! LED bulbs and certain metal parts emit strong heat when used! Do not point lamps too close to persons. Always use the fixtures with the front part closed.

NOTICE - EQUIPMENT OVERHEATING RISK

Do not obstruct ventilation by placing filters, diffusing materials, etc. over inlets and outlets of the equipment ventilation or directly over glass cover or LED bulbs.

FINAL DISPOSAL

When no longer in use, this product may not be deposited in the normal household waste but should be brought to a collection point for the recycling of electrical and electronic appliances. The materials are recyclable as marked. By re-use, recycling or another form of using old appliances you are making an important contribution towards the protection of the environment. Please ask your local authorities for the appropriate disposal point. Equipment contains electrical and electronic components that could be harmful to the environment.

Equipment may be returned to Lupo distributors free of charge for recycling according to WEEE.

Follow local legal requirements for separate disposal of waste, for instance WEEE directive for electrical and electronic equipment on the European market, when product life has ended!

MAINTENANCE AND CARE

Please do not forget that the safe operation of lampheads also includes their maintenance and care. A visual inspection should be conducted before every use and an inspection of electrical safety should be conducted at least once every 12 months.

WARRANTY

Each Lupo product will be repaired free of charge by Lupo if during a period of **12 months** for mechanical components and **12 months** for electrical/electronic components from date of purchase its working order is impaired through a manufacturing or material defect. The faulty product should be immediately sent to authorized dealer or Lupo. This warranty is not valid for equipment which has been used improperly, dismantled, modified or repaired by persons not belonging to the Lupo distribution network. It does not cover lamps, lenses or the material entirely or partially made of glass. No responsibilities can be accepted for damage resulting from unsatisfactory operation of the equipment. Please contact the dealer who sold the fixture/s before any units are returned for repair. Lupo will make the final determination as to whether or not the unit is covered by warranty. Lupo will replace or repair to proper working condition any products that are returned under warranty. Products repaired or replaced under warranty are under warranty only for the remaining unexpired period of time of the original warranty. Any product unit or part returned to Lupo must be packaged in a suitable manner to ensure the protection of such product unit or parts. The package must be clearly and prominently marked to indicate that the package contains returned product units or parts. All returned product units or parts must be accompanied by a written explanation of the alleged problem or malfunction.

⚠ WARNING:

When hanging the fixture from higher position, please make sure you use a safety cable to attach the barndoors to the yoke of the fresnel.

Barndoors should always be secured to the yoke when used in this way.

Another safety cable should be used to secure the fixture to the mounting pipe or truss.

Both safety cables must be properly dimensioned for the fixture and the application when the fixture is operated in hanging position please ensure that the accessories are installed correctly with top latch locked.

*Thanks for having purchased **Lupo** products. All the products are made in Italy and all the efforts have been put to keep the quality standards high. We hope this product can help you in your job and make your life easier as a professional. We also hope you will enjoy its use and we would be happy to receive your feedback about it.*

Instructions

- Device for indoor use only.
- Protection standard IP20.
- Maximum ambient temperature: 40 °C.
- Make sure power supply plug is suitable to power required.
- As prescribed by international regulations, a safety cable must be used when the fixture is suspended from ceiling.
- To switch on the light push the on/off button.
- Dayled 650 and Dayled 1000 models are equipped with new generation high quality LED arrays.
- Dayled 650 is equipped with 60 W single LED array.
- Dayled 1000 is equipped with 110 W single LED array.
- Dayled 2000 is equipped with 220 W single LED array.

Package Contents

Dayled model + Barndoors

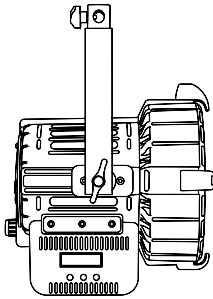

Dayled 2000

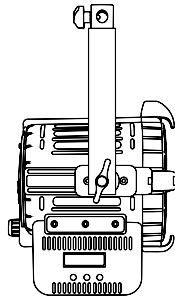

Dayled 1000

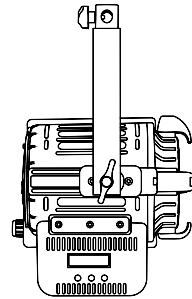

Dayled 650

▲ ATTENTION: Please keep the original package of the product in a safe place for warranty reasons.

Getting Started

Dayled 2000

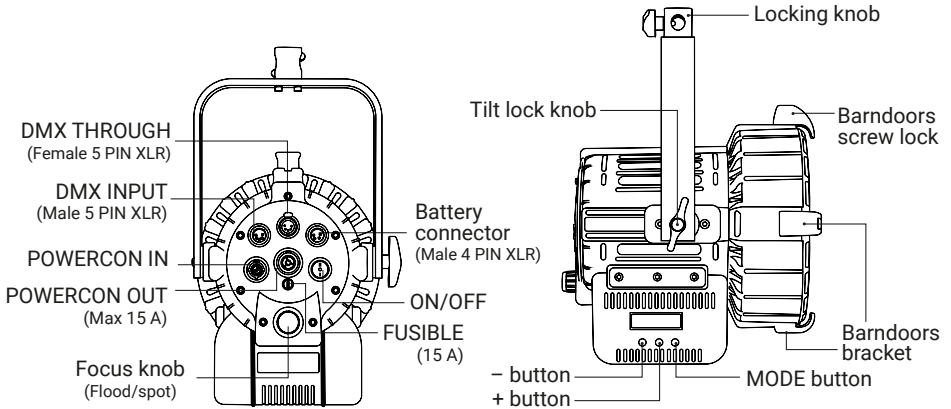

Dayled 1000

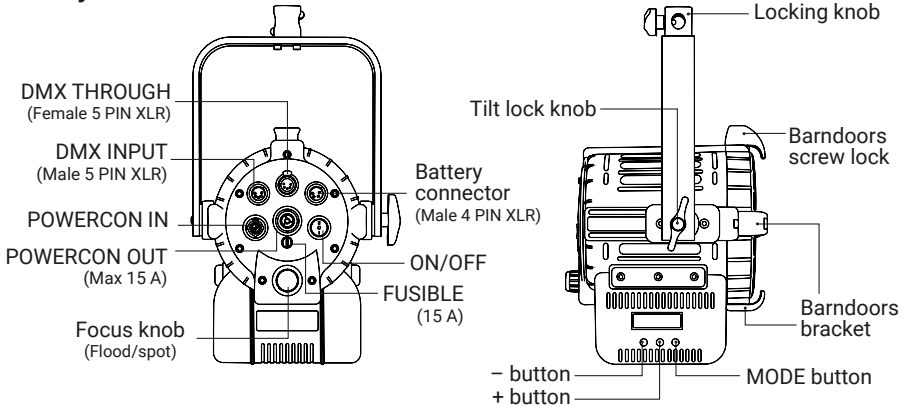

Dayled 650

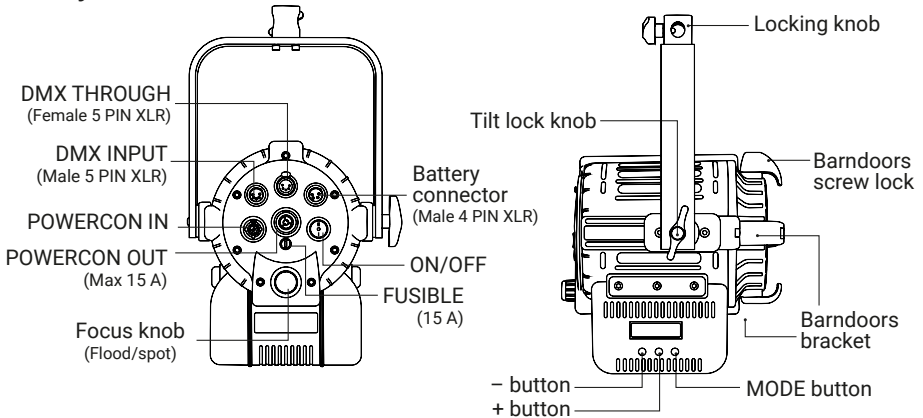

Functioning

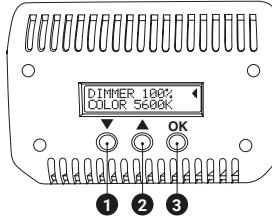

OPERATION MODE

1 Manual Operation

Press the « OK » **3** button to shift between the functions **DIMMER**, **COLOR***, **STROBE PAGE**, **MANUAL** and **MENU**. The indicator « **4** » shows the selected function.

- **DIMMER**: Use the « **▼** » **1** or « **▲** » **2** buttons to adjust the luminous intensity level from **0** to **100%**.
- **COLOR***: Function available only the Dual Color version*. Use the « **▼** » **1** or « **▲** » **2** buttons to adjust the color temperature from **2800K** to **6500K**.
- In the **STROBE PAGE** it is possible to set the **STROBE** frequency by pressing « **▼** » **1** or « **▲** » **2**

ATTENTION: STROBE frequency = 0 means **STROBE** effect **OFF**.

- DMX (ON/OFF):

1. Select **DMX SEL** by pressing the button.
2. Press « **▼** » **1** or « **▲** » **2** to activate the functions.

- MENU (ON/OFF):

1. Select **MENU SEL** by pressing the button.
2. Press « **▼** » **1** or « **▲** » **2** to activate the functions.

2 DMX Operation

Press the **3** button to shift between the functions **DMX ADDRESS**, **MANUAL** and **MENU**. The indicator « **4** » shows the selected option.

- **DMX ADDRESS**: Press the « **▼** » **1** or « **▲** » **2** buttons to select the DMX channel between **1** to **512**.
- **MANUAL**:
 1. To return to the **MANUAL OPERATION**, select **MANUAL** by pressing the **3** button.
 2. Press the « **▼** » **1** or « **▲** » **2** button to confirm the selection.

ADVANCED FEATURES

Long press the « OK » **3** button to enter the advanced features menu.

1. Use the **1** or **2** buttons to navigate between the main MENU options: **MANUAL / DMX / BLUETOOTH / DEVICE SETTINGS / RESET DEVICE / INFO**.
2. Use the **3** button to select an option.

1 Manual Options

1. Use the « **▼** » **1** or « **▲** » **2** button to select between the **MONOCOLOR / CCT MODE*** and **EFFECT MODE**.
2. Press the « OK » **3** button to confirm the selection.

*The mode name changes according to the Dayled model (monocolor or dual color).

1. Use the «▼» ❶ or «▲» ❷ buttons to select between the **MONOCOLOR / CCT MODE*** and **EFFECT MODE**.
 2. Press the «OK» ❸ button to confirm the selection.
- *The mode name changes according to the Dayled model (monocolor or dual color).*

EFFECT MODE:

1. **TELEVISION BW** only available on dual color version
2. **PAPARAZZI / LIGHTNING** all versions

Television:

Press the «OK» ❸ button to shift between **DIMMER, RANGE, FREQUENCY, TELEVISION (ON/OFF)** functions. The indicator «⚡» shows the selected function.

1. Press «▼» ❶ or «▲» ❷ buttons to adjust the functions.
- **DIMMER:** Use the «▼» ❶ or «▲» ❷ buttons to adjust the luminous intensity level from **0 to 100%**.
 - **RANGE:** White color range:
 1. **2800 K - 4000 K**
 2. **4000 K - 5200 K**
 3. **5200 K - 6500 K**
 4. **2800 K - 6500 K**
 - **FREQ:** Use the «▼» ❶ or «▲» ❷ buttons to adjust frequency from **1 Hz to 25 Hz**.

- **TELEVISION (ON/OFF):**

Select **TELEVISION ON** by pressing the «▼» ❶ or «▲» ❷ buttons to disable the television effect.

Paparazzi:

Press the «OK» ❸ button to shift between **DIMMER, INT., BULB, PAPARAZZI (ON/OFF)** functions. The indicator «⚡» shows the selected function.

2. Press «▼» ❶ or «▲» ❷ buttons to adjust the functions.
- **DIMMER:** Use the «▼» ❶ or «▲» ❷ buttons to adjust the luminous intensity level from **0 to 100%**.
 - **INT.:** Use the «▼» ❶ or «▲» ❷ buttons to adjust the **light intensity from 0 to 100%**.
 - **BULB:** Flash bulb type (Flash on duration)
 - **PAPARAZZI (ON/OFF):**

Select **PAPARAZZI ON** by pressing the «▼» ❶ or «▲» ❷ buttons to disable the paparazzi effect.

Lightning: *The Lightning effect is applied to the last set parameters of the CCT or MONOCOLOR mode.*

1. Press the «MODE» ❸ button to shift between **DIMMER, CT, INT., LIGHTNING (ON/OFF)** functions. The indicator «⚡» shows the selected function.
 2. Press «▼» ❶ or «▲» ❷ buttons to adjust the functions.
- **DIMMER:** Use the «▼» ❶ or «▲» ❷ buttons to adjust the luminous intensity level from **0 to 100%**.
 - **CT:** Use the «▼» ❶ or «▲» ❷ buttons to adjust the **colour temperature (CCT) values from 2800K to 6500K**.
 - **INT.:** Use the «▼» ❶ or «▲» ❷ buttons to adjust the **light intensity from 0 to 100%**.
 - **LIGHTNING (ON/OFF):**
- Select **LIGHTNING ON** by pressing the «▼» ❶ or «▲» ❷ buttons to disable the lightning effect.

2 DMX Options

1. Use the «▼» ❶ or «▲» ❷ buttons to select between the **MONOCOLOR / CCT MODE*** and **EFFECT MODE**.
 2. Press the «OK» ❸ button to confirm the selection.
- *The mode name changes according to the Dayled model (monocolor or dual color).*

EFFECT MODE:

1. Press the «OK» ❸ buttons to select the **STROBE**. Available only in manual operation.
2. To activate the effect, select **ON** by pressing the «OK» ❸ button.

3 Device Settings

1. Use the «▼» ① or «▲» ② buttons to select between **DMX OPERATION / DMX BIT / DMX SIGNAL LOSS**.
2. Press the «OK» ③ button to confirm the selection.

DMX BIT: Resolution of the DMX control.

1. Press the «OK» ③ button to enter to the **DMX BIT** options.
2. Use the «▼» ① or «▲» ② buttons to select between **8bit** or **16bit**.
3. Press the «OK» ③ button to confirm the selected setting. **See protocol DMX.**

8bit: 1 channel per function. **16 bit:** 2 channels per function.

DMX SIGNAL LOSS: This allows to choose the device's behaviour in case of a DMX signal loss.

1. Select the **DMX SIGNAL LOSS** item with the ③ button.
2. Use the «▼» ① or «▲» ② buttons to select the device's behaviour between **BLACK OUT / SETTINGS LAST/ SETTINGS 1min**.
3. Press the «OK» ③ button to confirm the setting.

Black out: The device switches off. **Settings Last:** The values of the last selected setting are maintained over time until the device is switched off. **Settings 1min:** The values of the last selected settings will be maintained for one minute and then the device will switch off.

1. Press the «OK» ③ button to enter the **DEVICE SETTINGS** options.
2. Use the «▼» ① or «▲» ② buttons to select between **DISPLAY / FILTER / LINEARIZATION**.
3. Press «OK» ③ button to confirm the selection.
4. Within each function select the option to be activated, use the «▼» ① or «▲» ② buttons to select one between the options, press «OK» ③ button to activate it.

Display: **30sec / 1min / ALWAYS ON.** Time during which the display backlight stays on.

Filter: **FULL SPEED / NORMAL SPEED / HIGH SPEED / LOW SPEED.** It is the speed response of the system (smooth factor).

Linearization: **LINEAR / EXPONENTIAL / LOGARITHMIC.** Linearization is the compensation curve for the human eye's perception of the luminous intensity emitted as a function of the required power (required power = dimmer value on the display).

- **Linear:** No compensation, the intensity of the light is directly proportional to requested power
- **Exponential:** The light intensity increases from 0 to 100 exponentially.
- **Logarithmic:** The light intensity increases from 0 to 100 logarithmically.

4 Reset Device

1. To set the factory settings, select **YES** by pressign the ② button.
2. Press «OK» ③ to confirm the selection.
3. The device will ask for further confirmation, select **YES** by pressing the ② button.
4. Press «OK» ③ to confirm the selection.

FACTORY SETTINGS: Mode: CCT or MONOCOLOR - DMX: Off - Bit: 8bit - DMX signal loss: Settings 1 Min - Display: 1 Min - Filter: Normal Speed - Linearization: Linear

BLUETOOTH

Enable / Disable BLE App interface

DMX Protocol

DMX Channel Protocol - 8 bit		
MODE	CHANNELS USED	DMX CHANNEL POSITION
CCT	3	1. DIMMER
		2. COLOR TEMPERATURE*
		3. STROBE **
TELEVISION*	3	1. DIMMER
		2. WHITE RANGE
		3. FREQUENCY
PAPARAZZI*	3	1. DIMMER
		2. INTERVAL
		3. BULB TYPE
LIGHTNING*	3	1. DIMMER
		2. COLOR TEMPERATURE
		3. INTERVAL
DMX Channel Protocol - 16 bit		
MODE	CHANNELS USED	DMX CHANNEL POSITION
CCT or MONOCOLOR	6	1. DIMMER - byte 1
		2. DIMMER - byte 2
		3. COLOR TEMPERATURE - byte 1*
		4. COLOR TEMPERATURE - byte 2*
		5. STROBE - byte 1**
		6. STROBE - byte 2**
TELEVISION*	6	1. DIMMER - byte 1
		2. DIMMER - byte 2
		3. WHITE RANGE - byte 1
		4. WHITE RANGE - byte 2
		5. FREQUENCY - byte 1
		6. FREQUENCY - byte 2
PAPARAZZI*	6	1. DIMMER - byte 1
		2. DIMMER - byte 2
		3. INTERVAL - byte 1
		4. INTERVAL - byte 2
		5. BULB TYPE - byte 1
		6. BULB TYPE - byte 2
LIGHTNING*	6	1. DIMMER - byte 1
		2. DIMMER - byte 2
		3. COLOR TEMPERATURE - byte 1
		4. COLOR TEMPERATURE - byte 2
		5. INTERVAL - byte 1
		6. INTERVAL - byte 2

**Channel in use only the Dual Color version.*

*** Only available if enabled in DMX ADVANCED.*

Advanced Features Menu e Sub - Menus

- Select "EXIT" with the « OK » 3 button to return to the last selected mode.
- Select "BACK" with the « OK » 3 button to return to the previous menu.

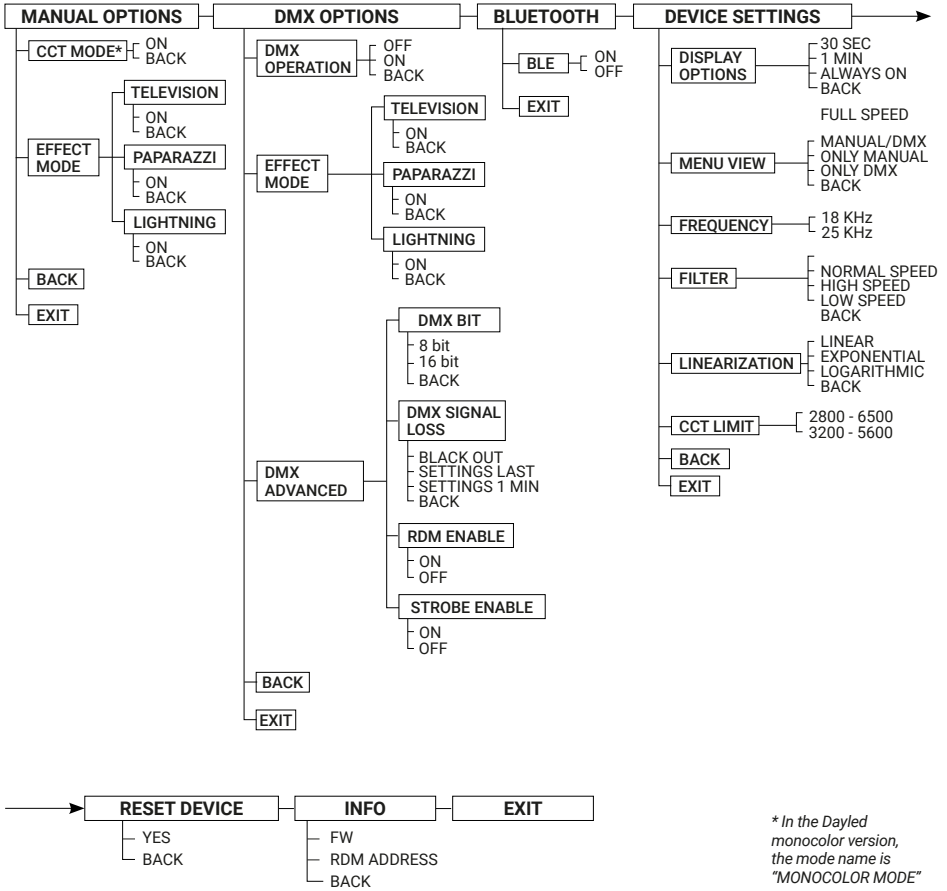

NOTE: After 1 minute of inactivity in the menu, the device automatically exits and returns to the last selected mode.

Dayled PRO. Professional LED Fresnels.

Accessories

The accessories are products sold separately.

COMPLETE KIT OF V-MOUNT BATTERY POWER SUPPLY FOR DAYLED 650 AND 1000.

The items are also sold separately.

Battery charger (cod.272)

This charger works with Lupo 95 Wh and 160 Wh batteries.

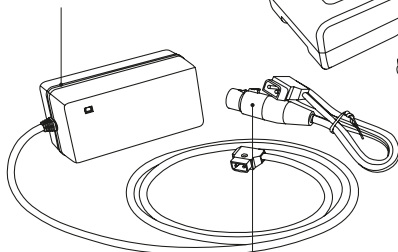

D – Tap cable (cod.313)

Dayled 650 / 1000

95 Wh battery (cod.271)

Dayled 2000

160 Wh battery (cod.271)

This batteries allows to power all Lupo models with AC/DC functioning.

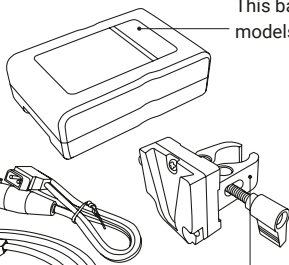

V – Mount clamp (cod.320)

Clamp for stand only is an essential accessory for lithium battery powered equipment. It accepts all standard V-Mount batteries.

Lupo
MOUNTED BY

eqc
extreme quality control

Lupo srl - Via V. Sassi 28/30 Collegno (TO) - 10093 - Italy

Phone: +39 011 411 9919 / e-mail: contact@lupo.it / website: www.lupo.it

Extreme Quality Control S.L. - Calibre 55 - Collado Villalba - 28400 - Madrid, Spain

Phone: +34 918 505 087 / e-mail: info@eqcgrupo.com / website: www.eqcgrupo.com